

Frontplattenausschnitt (Rückseite)
Panel cut out (rear side)

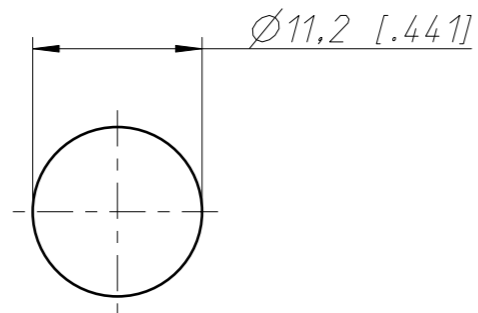

Sheet Number 1/1	Projection 	Scale 2:1	Format A3	Tolerancing ISO 2768-mK	
ECN Number -		Created 20.02.2003	noe		
Description NMJ3HF-S			Modified 22.02.2021	mmu	
			Approved 23.02.2021	phk	
			Status Released		
NEUTRIK		3D Model ID NMJ3HF-S	Document ID ST-NMJ3HF-S	Revision -	