



# User Manual

Applies to XIRIUM PRO US devices

XIRIUM  

---

PRO

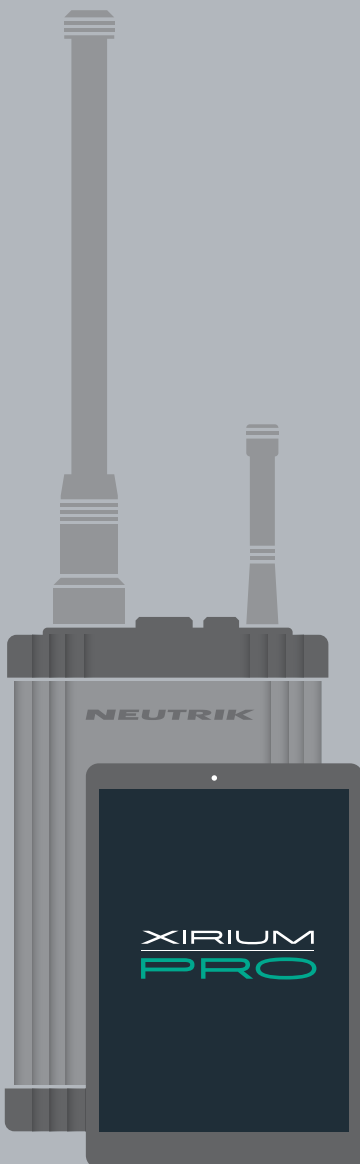

**NEUTRIK®**

## Imprint

Subject to change due to technical advances! This user manual corresponds to the level of technology at the time the product was delivered and not the current stage of development at Neutrik.

If any pages or sections of this user manual are missing, please contact the manufacturer at the address listed below.

### Copyright

This user manual is protected by copyright. The user manual must not be duplicated, reproduced, microfilmed or translated, or converted to be saved and processed in EDP systems, neither as excerpts nor in full, without the express written authorization of Neutrik.

Copyright by: © Neutrik® AG

### Document identification

Document No: BDA 470-V8

Version: 2020/05

 ▶ **This user manual applies to firmware 4.0 and app version 5.2!**

Language: English

Original language: German

Each user manual in a different language is a translation of the operating manual in German.

### Manufacturer

Neutrik® AG  
Im alten Riet 143  
9494 Schaan  
Liechtenstein

T: +423 2372424

F: +423 2325393

E: [neutrik@neutrik.com](mailto:neutrik@neutrik.com)

[www.neutrik.com](http://www.neutrik.com)



# Table of contents

<b>1 About this document</b> .....	<b>4</b>	<b>5 Operation</b> .....	<b>31</b>
1.1 Significance of the user manual .....	4	5.1 Setting devices into operation .....	31
1.2 Designation .....	4	5.2 Setting up the transmission path .....	32
1.3 Explanation of symbols .....	5	5.3 Installing and starting the app .....	33
1.3.1 Symbols in illustrations .....	5	5.3.1 Location Services .....	33
1.4 Target group .....	5	5.3.2 Starting the app .....	34
<b>2 Safety</b> .....	<b>6</b>	5.4 Connecting devices with the app .....	34
2.1 Warning information and signal words .....	6	5.4.1 Connecting devices in stand-alone mode .....	34
2.2 Warning symbols .....	6	5.4.2 Connecting devices in network mode .....	35
2.3 Important regulatory notes .....	7	5.5 Arranging the radio transmission path .....	38
2.3.1 Radio frequency radiation exposure informa- tion .....	7	5.6 Configuring the device parameters .....	39
2.4 Important safety instructions .....	8	5.7 Editing system settings .....	43
2.5 Proper use .....	9	5.7.1 System reset .....	43
2.6 Foreseeable improper use .....	9	5.7.2 Advanced Mode .....	43
<b>3 Components and accessories</b> .....	<b>10</b>	5.8 Setting up and mounting the XIRIUM PRO system .....	44
3.1 XIRIUM PRO components .....	10	5.8.1 Positioning the devices .....	44
<b>4 Description of product</b> .....	<b>12</b>	5.8.2 Positioning the repeater .....	45
4.1 XIRIUM PRO base station .....	12	5.8.3 Systems with several transmitters .....	45
4.2 Modules .....	13	5.8.4 Fastening and securing XIRIUM PRO devices .....	46
4.2.1 TX modules .....	13	5.9 Upgrading firmware .....	47
4.2.2 RX modules .....	13	5.9.1 Installing the XIRIUM PRO Firmware Upgrade Manager .....	47
4.3 XIRIUM PRO app .....	14	5.9.2 Executing a firmware upgrade .....	48
4.3.1 Overview of operation elements .....	14	5.9.3 Uninstalling the XIRIUM PRO Firmware Upgrade Manager .....	50
4.3.2 Links/Overview page .....	16	<b>6 Troubleshooting</b> .....	<b>51</b>
4.3.3 Edit page .....	17	<b>7 After operation</b> .....	<b>52</b>
4.3.4 Settings page .....	20	7.1 Dismounting devices .....	52
4.3.5 Help page .....	21	7.2 Transporting .....	52
4.4 Getting started .....	22	7.3 Storage .....	52
4.4.1 App .....	23	7.4 Cleaning and care .....	52
4.4.2 Repeater .....	23	7.5 Maintenance and repair .....	52
4.4.3 Signal quality bar .....	23	7.6 Disposal .....	53
4.4.4 Transmission power .....	24	<b>8 Appendix</b> .....	<b>54</b>
4.4.5 XROC mode .....	25	8.1 Integrating DANTE® .....	54
4.4.6 Antennas .....	25	8.1.1 Introduction to DANTE® .....	54
4.4.7 Remote antennas .....	27	8.1.2 Enabling a DANTE® link .....	54
4.4.8 Antenna combinations .....	27	8.2 Access point settings .....	55
4.4.9 Line-of-sight and redundant RF path .....	29	8.2.1 Recommended settings .....	55
4.4.10 Antenna height + distance .....	29	8.2.2 XIRIUM PRO basic kit with access point .....	55
4.4.11 RF attenuator .....	29	8.3 Technical specifications .....	56
4.5 Selecting transmission channels .....	30		
4.5.1 Automatic selection of transmission channels .....	30		
4.5.2 Manual selection of transmission channels .....	30		



# 1 About this document

This user manual provides an overview of the necessary operation steps and settings of the product.

## 1.1 Significance of the user manual

**i** This user manual is an integral component of the product and part of the product's safety concept.

- ▶ Make sure that all persons who work with the product have fully read and also understood this user manual.
- ▶ Observe all instructions exactly, especially the safety instructions.

**i** This user manual contains important information for operating and maintaining the product and troubleshooting minor problems safely and properly on your own.

- ▶ Keep this user manual in the immediate vicinity of the product so personnel have access to it at all times.

- ▶ Pass this user manual on to every user, e.g., by lending it, or to the future owner of the product.
- ▶ If this user manual is lost or damaged, a copy of the operating manual can be downloaded from the Neutrik's home page ([www.neutrik.com](http://www.neutrik.com)).

## 1.2 Designation

Designation	Explanation
XIRIUM PRO System	All components: XIRIUM PRO base stations, XIRIUM PRO modules, cables, plugs, antennas
XIRIUM PRO base station	XIRIUM PRO TX (transmitter) without module, short TX XIRIUM PRO RX (receiver) without module, short RX
XIRIUM PRO module	Exchangeable module for the XIRIUM PRO base station
XIRIUM PRO device	XIRIUM PRO base station with module plugged-in
XROC mode	Extreme Ruggedized One Channel mode for a secure connection in extreme situations.
Peripheral devices	All devices which can be connected with each other via the XIRIUM PRO devices: audio sources (transmitters) and audio sinks (receivers)
Audio source	All devices which emit a signal
Audio sink	All devices which receive the audio signals, e.g., loudspeakers, audio systems (amplifiers, mixing consoles, etc.)
Transmission path	Wireless connection between the XIRIUM PRO devices. A transmission path consists of 1 TX, 1 repeater (optional) and at least 1 RX.
Network	All devices used which are connected to the app via an access point.

## 1.3 Explanation of symbols

In order to make this user manual easier to understand, uniform safety instructions, symbols, terms and abbreviations were used. The following symbols designate instructions which are not relevant to safety, yet make it easier to understand the operating manual.

- ✔ The preconditions for an action are depicted with this symbol. Complete the specified items before carrying out the action steps which follow.
  - ▶ Action steps are designated by this symbol. Carry out the action steps in the order they are presented.
  - ✔ The result of the action or the reaction of the product to the action are depicted with this symbol.
    - Lists without a mandatory sequence are presented as a list with this bullet.
1. Numbered listings are displayed in this manner.  
(1) Refers to a position in an illustration.

Texts in this color designate elements on the app surface.



Wherever you see this symbol, you will find useful information for safe, trouble-free operation of the product.

### 1.3.1 Symbols in illustrations

Symbol	Explanation
	Image position
	Action steps numbered in an illustration. Carry out the action steps in the order they are presented.
	Only carry out these tasks when using an Apple iPad.
	Only carry out these tasks when using an Android tablet.

## 1.4 Target group

This user manual is directed to sound engineers and professional personnel who have detailed experience in the sound and event technology.

Personnel who are in training must only work with this device under the supervision of experienced persons.

## 2 Safety

### 2.1 Warning information and signal words

Special warning information regarding potential dangers inherent in a particular action are presented before instructions for an action. The warnings are ranked as follows:

**⚠ DANGER**

**Immediate threat of danger!**

This type of warning points out a situation which would result in death or severe injuries.

- ▶ If this warning is not heeded, the threat of death or serious injuries is imminent.

**⚠ WARNING**

**Possible threat of danger!**

This type of warning points out a situation which could result in death or severe injuries.

- ▶ If this warning is not heeded, the threat of death or serious injuries might be imminent.

**⚠ CAUTION**

**Possible threat of danger!**

This type of warning points out a situation which could result in minor or moderate injuries.

- ▶ If this warning is not heeded, minor injuries may result.

**⚠ NOTICE**

**Possible threat of property damage!**

This type of warning points out a situation which could result in damage to the device and its components.

- ▶ If this warning is not heeded, property damage may result.

### 2.2 Warning symbols

Symbol	Warning
	General warning
	Warning of hearing impairment
	Danger of electric shock

## 2.3 Important regulatory notes

This equipment has been tested and found to comply with the limits for a Class B digital device, pursuant to Part 15 of the FCC Rules. These limits are designed to provide reasonable protection against harmful interference in a residential installation. This equipment generates, uses and can radiate radio frequency energy and, if not installed and used in accordance with the instructions, may cause harmful interference to radio communications. However, there is no guarantee that interference will not occur in a particular installation. If this equipment does cause harmful interference to radio or television reception, which can be determined by turning the equipment off and on, the user is encouraged to try to correct the interference by one or more of the following measures:

- Reorient or relocate the receiving antenna.
- Increase the separation between the equipment and receiver.
- Connect the equipment into an outlet on a circuit different from that to which the receiver is connected.
- Consult the dealer or an experienced radio/TV technician for help.

### NOTICE

This device complies with Part 15 of the FCC Rules.

Operation is subject to the following two conditions:

1. this device may not cause harmful interference, and
2. this device must accept any interference received, including interference that may cause undesired operation.

### NOTICE

Changes or modifications made to this equipment not expressly approved by Neutrik may void the FCC authorization to operate this equipment.

### NOTICE

This device must be professionally installed.

### 2.3.1 Radio frequency radiation exposure information

This equipment complies with FCC radiation exposure limits set forth for an uncontrolled environment. This equipment should be installed and operated with minimum distance of 0,65 ft (20 cm) between the radiator and your body.

This transmitter must not be co-located or operating in conjunction with any other antenna or transmitter.

## 2.4 Important safety instructions

### **⚠ WARNING**

#### **Risk of fire or electric shock!**

- ▶ To reduce the risk of fire or electric shock, do not expose this device to rain or moisture and do not set any objects containing liquids on this apparatus.

### **⚠ WARNING**

#### **Danger of fire and explosion due to overheated battery!**

- ▶ Do not expose batteries or battery pack to excessive heat such as fire or other heat sources.
- To completely disconnect this apparatus from AC mains, disconnect the power supply cord plug from the AC socket.
- Keep the mains plug of the power supply cord readily accessible.

Avoid property damage to the XIRIUM PRO devices due to unsuitable operating and environmental conditions:

- Never immerse in water.
- Protect from strong sunlight.
- Never install the device near heat sources such as radiators, heating units, ovens or stoves.
- Never cover the device, to avoid overheating.
- Protect the device from impact and above all, from falling from poles, stages, tables or furniture.
- Always set up and fasten the device as shown in Section "5.8.4 Fastening and securing XIRIUM PRO devices" on page 45.

### Repair

### **⚠ DANGER**

#### **Danger of injury or electric shock and property damage due to improper repair!**

The XIRIUM PRO devices do not contain any parts which you can repair yourself. Opening or repairing the devices on your own can lead to severe damage to the devices and electrical shock or injuries to the operator.

- ▶ Do not open the housing of XIRIUM PRO devices under any circumstances.
- ▶ Do not exchange any parts yourself.
- ▶ Only have XIRIUM PRO devices repaired by a authorized specialist dealer.

### Electrical connection

### **⚠ DANGER**

#### **Danger of electric shock when connecting to or disconnecting from a power grid!**

- ▶ Only connect the devices to mains sockets installed by authorized electricians.
- ▶ Do not handle the devices with moist or wet hands under any circumstances.
- ▶ Make sure the specified mains voltage and mains frequency agree with the values of the power grid.
- ▶ Only use the delivered power supply cable for connecting to the socket.
- ▶ During storms or whenever there is a danger of power fluctuations, switch off the device and separate from the power grid.
- ▶ Ensure that the power supply cable is not kinked, hung over sharp edges or allowed to contact hot surfaces during operation.
- ▶ Do not use the devices if there is interference or damage to the devices, displays or accessories.



**Information for operation**

- ▶ Ensure that the ambient conditions specified for XIRIUM PRO are observed during operation.
- ▶ Do not use the XIRIUM PRO devices if they are not functioning properly, have fallen or been damaged, have become wet or if parts of the devices have been immersed in water.
- ▶ If disruptions occur during operation:  
Immediately switch off the XIRIUM PRO devices and disconnect them from the power grid.
- ▶ Do not operate the XIRIUM PRO devices in environments where flammable or explosive materials, gases or vapors are present or could occur.

**2.5 Proper use**

The XIRIUM PRO devices are intended for signal transmission between an audio source and an audio sink in accordance with the technical specifications.

**2.6 Foreseeable improper use**

The XIRIUM PRO devices are not suitable for use in potentially explosive atmospheres.

### 3 Components and accessories

#### 3.1 XIRIUM PRO components

The components and accessories are ordered individually.



Pos.	Description	Article no.
1	TX base station (TX base station, XIRIUM PRO USB data cable, Manfrotto™ universal mounting clamp, 5 GHz antenna, 2.4 GHz antenna)	NXP2TX
2	RX base station (RX base station, XIRIUM PRO USB data cable, Manfrotto™ universal mounting clamp, 2.4 GHz antenna)	NXP2RX
3	TX modules <ul style="list-style-type: none"> <li>• TX module analog</li> <li>• TX module AES</li> <li>• TX module DANTE (AES67 compliant)</li> </ul>	NXP-TM-ANA NXP-TM-AES NXP-TM-DANTE
4	RX modules <ul style="list-style-type: none"> <li>• RX module analog</li> <li>• RX module AES</li> <li>• RX module DANTE (AES67 compliant)</li> <li>• Repeater module</li> </ul>	NXP-RM-ANA NXP-RM-AES NXP-RM-DANTE NXP-RM-RP
5	5 GHz antenna 9 dBi 360°H 12.5°V	NXPA-9-360-12.5
6	5 GHz antenna 6 dBi 360°H 25°V	NXPA-6-360-25
7	5 GHz directional antenna 14 dBi 40°H 35°V, including adapter to mount the antenna directly on a receiver if no repeater module is inserted!	NXPA-14-40-35
8	2.4 GHz omnidirectional antenna for connecting app	NXPA-WIFI
9	5 GHz directional antenna (for remote setup) 18 dBi 18°H 18°V, for receiver if no repeater module is inserted! (cable not included!)	NXPA-18-18-18
10	5 GHz omnidirectional antenna 2 dBi 360°H 360°V, for repeater setups with different antenna heights (see page 26)	NXPA-2-360
11	Antenna cable S04162B, N type connectors, 5 m, 4 dB attenuation	NKXPA-5
12	N Adapter female female, for remote TX antenna (cable not included!)	NXPA-N-FF
13	Manfrotto™ universal mounting clamp	NXUC-M-15
14	Mounting arm for XIRIUM PRO antennas (NXPA-14-14-35, NXPA-18-18-18, NX-6-360-25), compatible with Manfrotto™ clamp	NXPMA
15	Power cable XIRIUM PRO, 3 m	NKXPF-5-15-3
16	XIRIUM PRO data cable	NKXP-DATA
17	Flight case with foam cut-outs to hold 2x base stations (not included)	CAS-NXP
18	Hard case (trolley) with foam cut-outs to hold 3 devices (not included)	CAS-NXP-T

## 4 Description of product

### 4.1 XIRIUM PRO base station

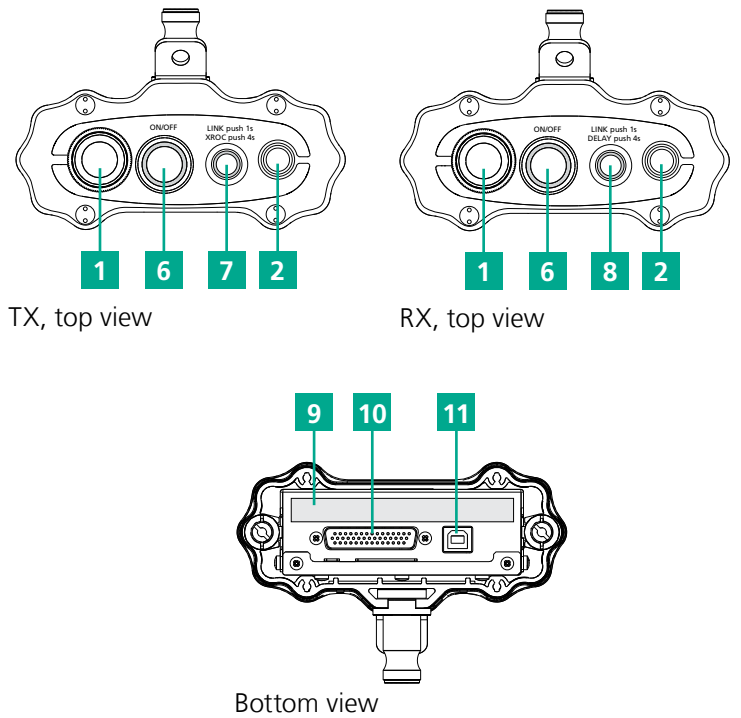
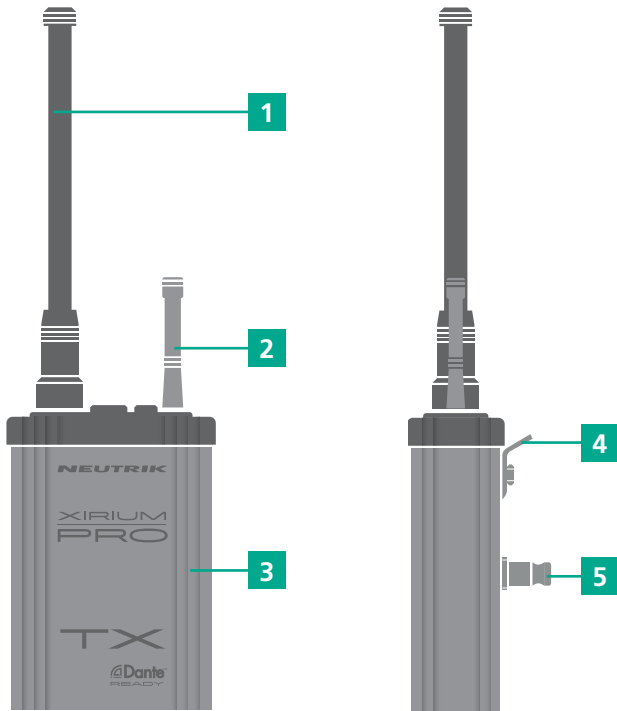

Pos.	Designation
1	<b>5 GHz antenna connector with 5 GHz antenna</b> The antenna transmits the signals between the XIRIUM PRO devices.
2	<b>2.4 GHz antenna connector (reverse SMA) with 2.4 GHz antenna</b> Transmits control data via WIFI
3	<b>Housing</b> Extruded aluminum housing
4	<b>Lug</b> Safety lug for additional fall arresting
5	<b>Bolt</b> Adapter for mounting with a Manfrotto™ clamp
6	<b>On/off switch</b> Powering the device ON/OFF, LED indication LED display: <ul style="list-style-type: none"> <li>• LED off: Device off or powering up.</li> <li>• LED solid green: Device powerd-on and battery level is between 20 % and 100 %.</li> <li>• LED slow-flash green: Device powerd-on and battery is charging.</li> <li>• LED solid red: Firmware update active.</li> <li>• LED slow-flash red: Device identification activated from app by pressing the <a href="#">Identify Device</a> button.</li> <li>• LED quick-flash red: Battery level is below 20 %.</li> </ul>

Pos.	Designation
7	<b>TX link button</b> Linking devices, switching XROC mode ON/OFF, resetting transmission power <ul style="list-style-type: none"> <li>• Push and release: Start/stop LINK process</li> <li>• Hold 4 sec: Toggle XROC mode ON/OFF</li> <li>• Hold 8 sec: Reset transmission power</li> </ul> LED display: <ul style="list-style-type: none"> <li>• LED off: TX not transmitting audio signal.</li> <li>• LED solid blue: TX transmitting audio signal.</li> <li>• LED quick-flash blue: Device is activated for linking process.</li> <li>• LED slow-flash blue: XROC mode set to ON.</li> </ul>
8	<b>RX link button</b> Linking devices; switching delay ON/OFF <ul style="list-style-type: none"> <li>• Push and release: Start/stop LINK process.</li> <li>• Hold 4 sec: Toggle delay ON/OFF.</li> <li>• Hold 8 sec: Reset repeater transmission power and set RF attenuator to "off".</li> </ul> LED display: <ul style="list-style-type: none"> <li>• LED off: RX not receiving audio signal.</li> <li>• LED solid blue: RX receiving audio signal.</li> <li>• LED quick-flash blue: Device is activated for linking process.</li> <li>• LED slow-flash blue: Delay set to ON.</li> </ul>
9	<b>Type plate</b> With serial number, SSID and WLAN password
10	<b>D-Sub connector</b> Interface between base station and module.
11	<b>USB port</b> USB connection for firmware update

## 4.2 Modules

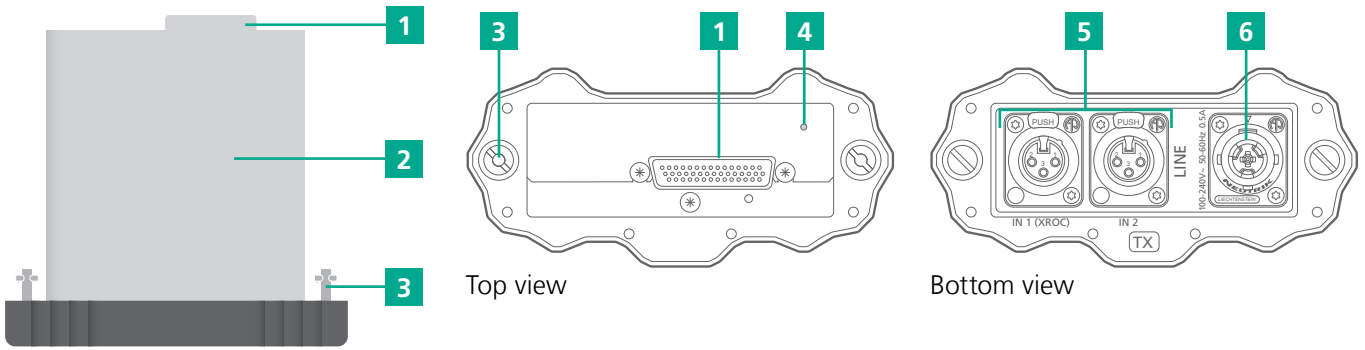

Pos.	Description
1	<b>D-Sub connector</b> interface between base station and module
2	<b>Module with integrated battery</b>
3	<b>Locking bolt</b>
4	<b>LED charging indicator</b> <ul style="list-style-type: none"> <li>Flashes green: Battery charging.</li> <li>Lit green: Battery fully charged.</li> </ul>

Pos.	Description
5	<b>Audio IN (TX), audio OUT (RX)</b> (different connections depending on module)
6	<b>powerCON TRUE1 chassis</b> for XIRIUM PRO power cable

### 4.2.1 TX modules

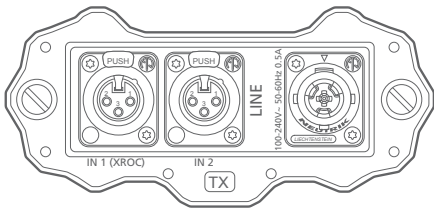

TX analog module

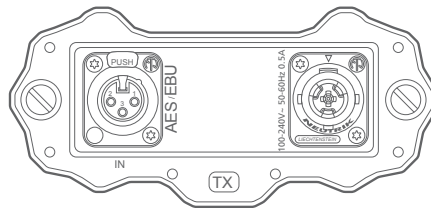

TX AES module

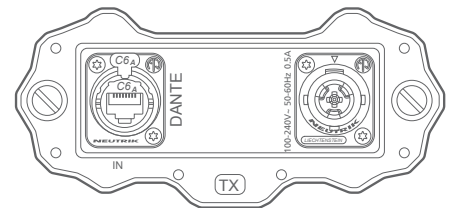

TX DANTE module

### 4.2.2 RX modules

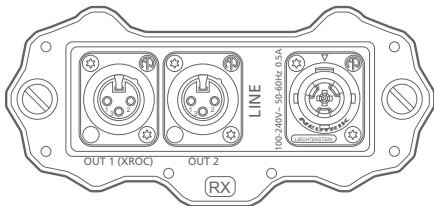

RX analog module

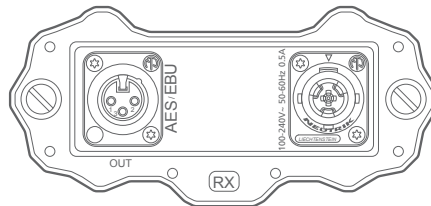

RX AES module

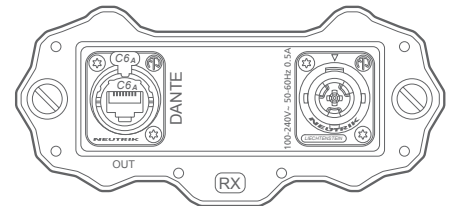

RX DANTE module

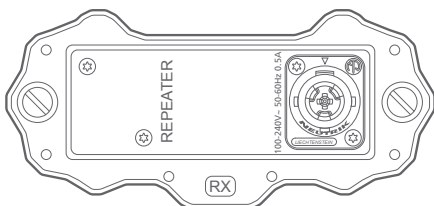

Repeater module

## 4.3 XIRIUM PRO app

The XIRIUM PRO app enables convenient operation and control of the devices from a tablet.

### 4.3.1 Overview of operation elements

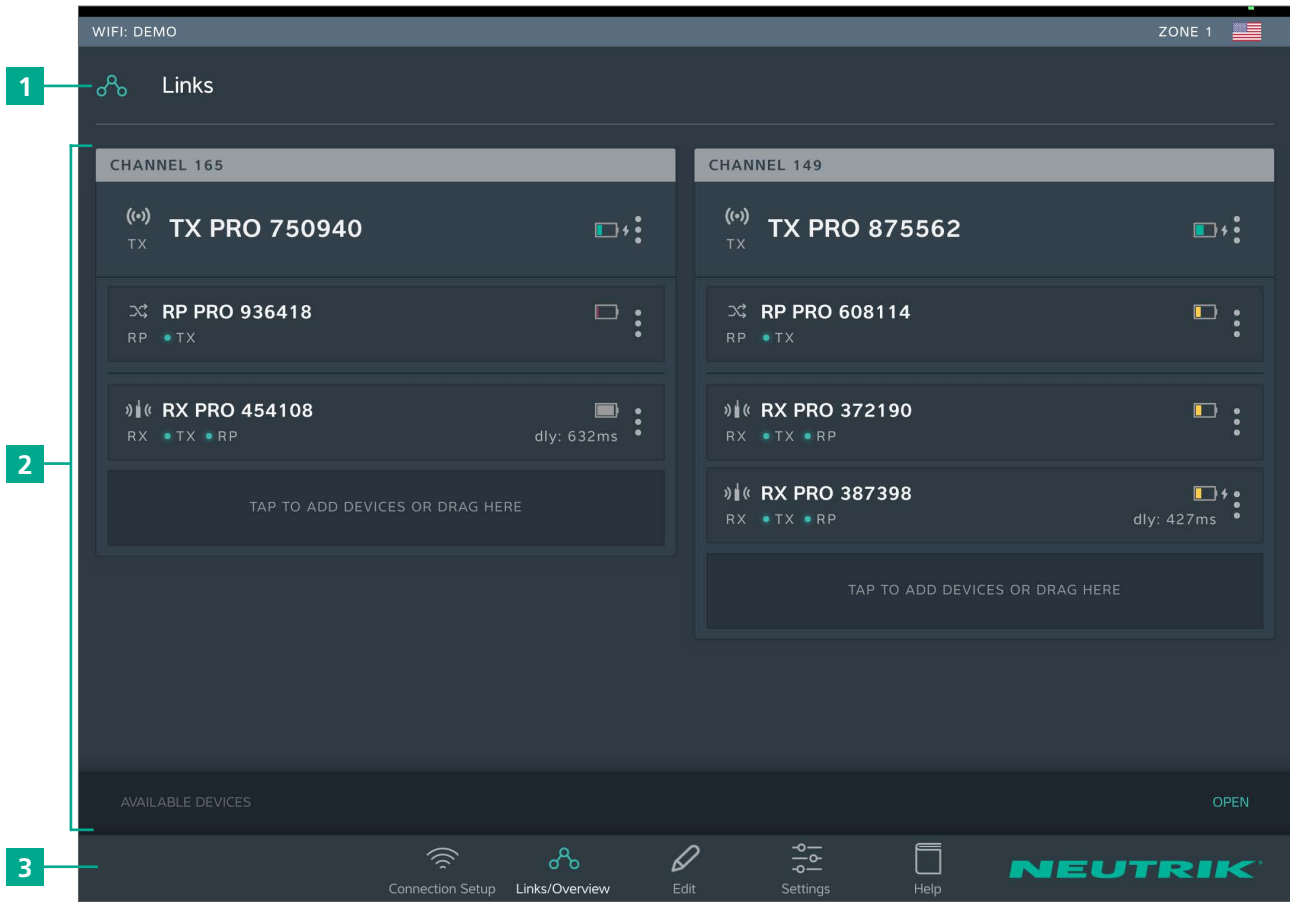

Pos.	Description
1	Page title
2	Operation and display area
3	Navigation bar

#### Navigation bar

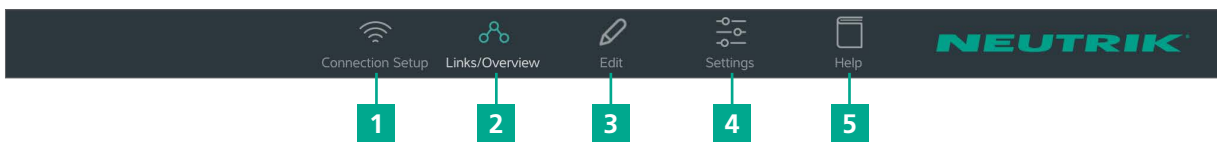

Pos.	Description
1	Connection setup button
2	Links/Overview button
3	Edit button

Pos.	Description
4	Settings button
5	Help button

- Tapping a button opens the associated page.
- When the page is active, the pictogram is green and the text is white.

## Symbols in the app

Symbol	Description
TX	The displayed device is a TX.
RP	The displayed device is a RX with a repeater module.
RX	The displayed device is a RX.
	<p>The battery level is between 40 % and 100 %.</p> <p>The battery level is below 40 %.</p> <p>The battery level is below 20 %. Connect the device to the mains supply.</p> <p>Animated display: Battery is charging.</p>
<ul style="list-style-type: none"> <li>• TX</li> <li>• TX</li> <li>• TX</li> </ul>	<p>The signal quality received from the TX is good, which refers to a proper RSSI level and a low packet loss.</p> <p>The signal quality received from the TX is critical. This is either due to a critical RSSI level or a critical packet loss. On <a href="#">Edit</a> page the signal quality bar is monitored in detail.</p> <p>The signal quality received from the TX is bad. This is either due to a bad RSSI level or a high packet loss. On <a href="#">Edit</a> page the signal quality bar is monitored in detail.</p>
<ul style="list-style-type: none"> <li>• RP</li> <li>• RP</li> <li>• RP</li> </ul>	<p>The signal quality received from the RP is good, which refers to a proper RSSI level and a low packet loss.</p> <p>The signal quality received from the RP is critical. This is either due to a critical RSSI level or a critical packet loss. On the <a href="#">Edit</a> page the signal quality bar is monitored in detail.</p> <p>The signal quality received from the RP is bad. This is either due to a bad RSSI level or a high packet loss. On the <a href="#">Edit</a> page the signal quality bar is monitored in detail.</p>
	<p>Display device options button</p> <p>Tapping this button opens the options menu.</p>
	Indicates that a message with information is pending for this device. The information is displayed in plain text on the <a href="#">Edit</a> page of the selected device.
	Mute icon: Indicates, if RX is muted
	Zone indicator: Displays to which country settings the devices in use are programmed.
	Advanced mode indicator: Displays, if advanced mode is switched ON.
LOW	Device temperature is LOW.
HIGH	Device temperature is HIGH.
dly: 800ms	Delay indicator: Indicates in the Links / Overview window if the delay on a RX is switched on.
RF: -30dB	RF attenuation indicator: Indicates in the Links / Overview window if the RF attenuation on a RX is switched on.



### 4.3.2 Links/Overview page

All devices that were added to the network via an access point are displayed on this page. The devices are grouped according to transmission path. Each transmission path is assigned to one transmission channel. In stand-alone mode, the Links/Overview page is inactive.

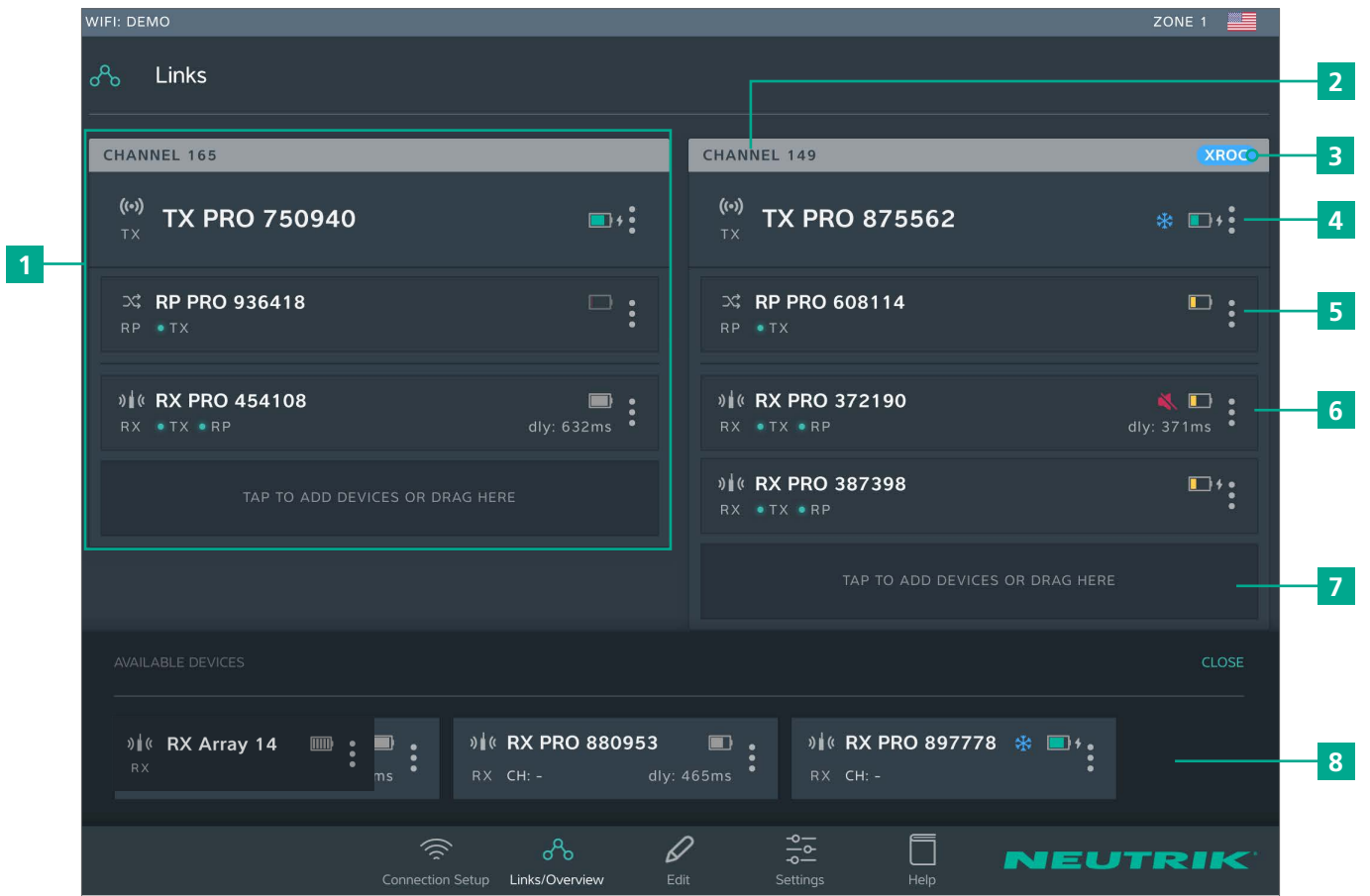

Pos.	Description
1	<b>Transmission path</b> This grouping displays all devices that are in one RF channel
2	<b>Transmission channel</b>
3	<b>XROC indicator</b> Is displayed when XROC mode is active for the RF channel
4	<b>TX display</b> 1 TX is needed for each transmission path
5	<b>Repeater display</b> As an option, repeaters may be used. A maximum 1 repeater per RF channel is possible. <ul style="list-style-type: none"> <li>The display is highlighted in red when there is a poor connection to the TX, or none at all.</li> </ul>

Pos.	Description
6	<b>RX display</b> Each field represents one device. A minimum 1 RX is needed for each transmission path. <ul style="list-style-type: none"> <li>The display is highlighted in red when there is a poor connection to the TX, or none at all.</li> </ul>
7	<b>Button for adding devices to transmission path</b> <ul style="list-style-type: none"> <li>Add a device: Use drag&amp;drop to add a device from <b>AVAILABLE DEVICES</b>.</li> <li>Add several devices: Tap button and select device from <b>AVAILABLE DEVICES</b>.</li> </ul>
8	<b>AVAILABLE DEVICES</b> Displays all available devices which have not yet been assigned to a transmission path. Tapping <b>OPEN/CLOSE</b> opens/closes the display.



## Device options menu

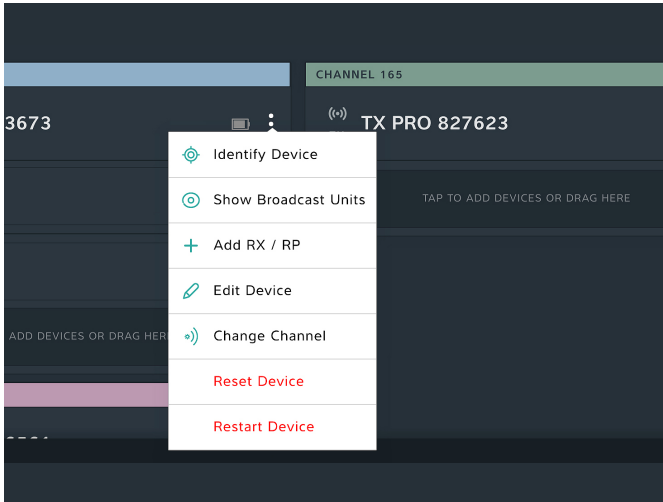

### Description

#### Identify Device

Tap the button to identify a single device: The power LED of the device slowly flashes red for about 10 seconds.

#### Show Broadcast Units

Tap the button: The power LEDs of all devices which are assigned to the same channel slowly flash red for about 10 seconds.

#### Add RX / RP

Select and add additional RX/RP to get linked to this TX

#### Edit Device

Opens the [Edit Device](#) page so all properties of the device can be edited.

#### Change channel

Opens a list of 5 GHz channels. Tap a channel to switch to this channel.

#### Reset Device

Resets device to factory state.

#### Restart device

Restarts the device without the need of pressing the hardware power button.

## 4.3.3 Edit page

### Edit TX

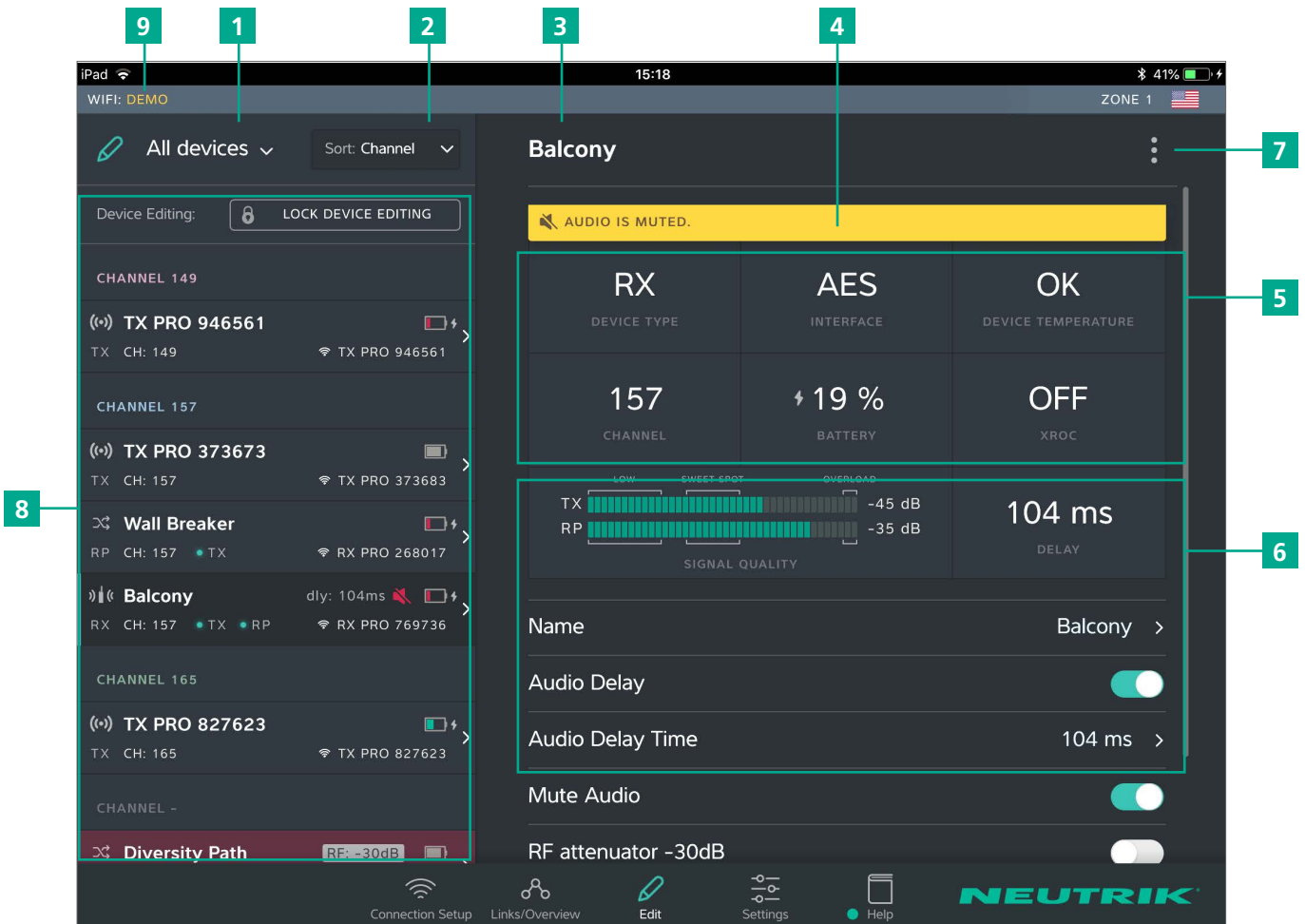



Pos.	Description	Pos.	Description
1	<p><b>Filter devices drop-down menu</b> Only the devices that meet the filter criteria are displayed.</p> <ul style="list-style-type: none"> <li>• <b>All Devices:</b> List all devices.</li> <li>• <b>Low Battery:</b> Only list devices on which the battery is weak.</li> <li>• <b>Out of Range:</b> Only list devices that receive a poor signal, or none at all.</li> </ul>	6	<p><b>Adjustable properties</b> Tapping on a property opens the associated sub-page.</p> <ul style="list-style-type: none"> <li>• <b>Name:</b> Opens the page for changing the device name.</li> <li>• <b>Channel:</b> Opens the page for changing the transmission channel.</li> <li>• <b>XROC:</b> Tapping this button toggles the XROC mode ON/OFF.</li> <li>• <b>Transmission Power:</b> Opens the page for adjusting the transmission power of the TX/repeater.</li> <li>• <b>Info &amp; Settings:</b> Opens a page with information about the device.</li> </ul>
2	<p><b>Sorting drop-down menu</b> Specifies the criteria for sorting the devices.</p> <ul style="list-style-type: none"> <li>• <b>Channel:</b> Devices are sorted according to channel.</li> <li>• <b>Type:</b> Devices are sorted according to type.</li> </ul>	7	<p><b>Device options</b></p> <ul style="list-style-type: none"> <li>• <b>Identify Device:</b> The power LED of the device selected will slowly flash for about 10 seconds</li> <li>• <b>Reset Device:</b> Resets the device to factory state</li> <li>• <b>Restart Device:</b> Manually restart the device by using this button</li> </ul>
3	<p><b>Device Name</b> Displays the device name entered by the user.</p>	8	<p><b>Overview of the connected devices</b> Lists all connected devices according the set filter and sorting criteria. The selected device is marked with a green bar and a dark background.</p>
4	<p><b>Note</b> Contains useful information for safe, trouble-free operation.</p>	9	<p><b>Name of access point used</b></p>
5	<p><b>Device Properties</b></p> <ul style="list-style-type: none"> <li>• <b>Device Type:</b> Device is a TX.</li> <li>• <b>Interface:</b> Indicates the module being used.</li> <li>• <b>Device Temperature:</b> Indicates the temperature of the device (low, ok or high)</li> <li>• <b>Channel:</b> Indicates the channel the device is transmitting on.</li> <li>• <b>Battery:</b> Indicates the battery charge status in %.</li> <li>• <b>XROC:</b> Indicates whether the XROC mode is ON/OFF.</li> </ul>		

**i** In standalone mode the [Allow link](#) button is shown on the [Edit](#) page. Tapping the [Allow link](#) button starts the connection process of the TX.

## Edit RX

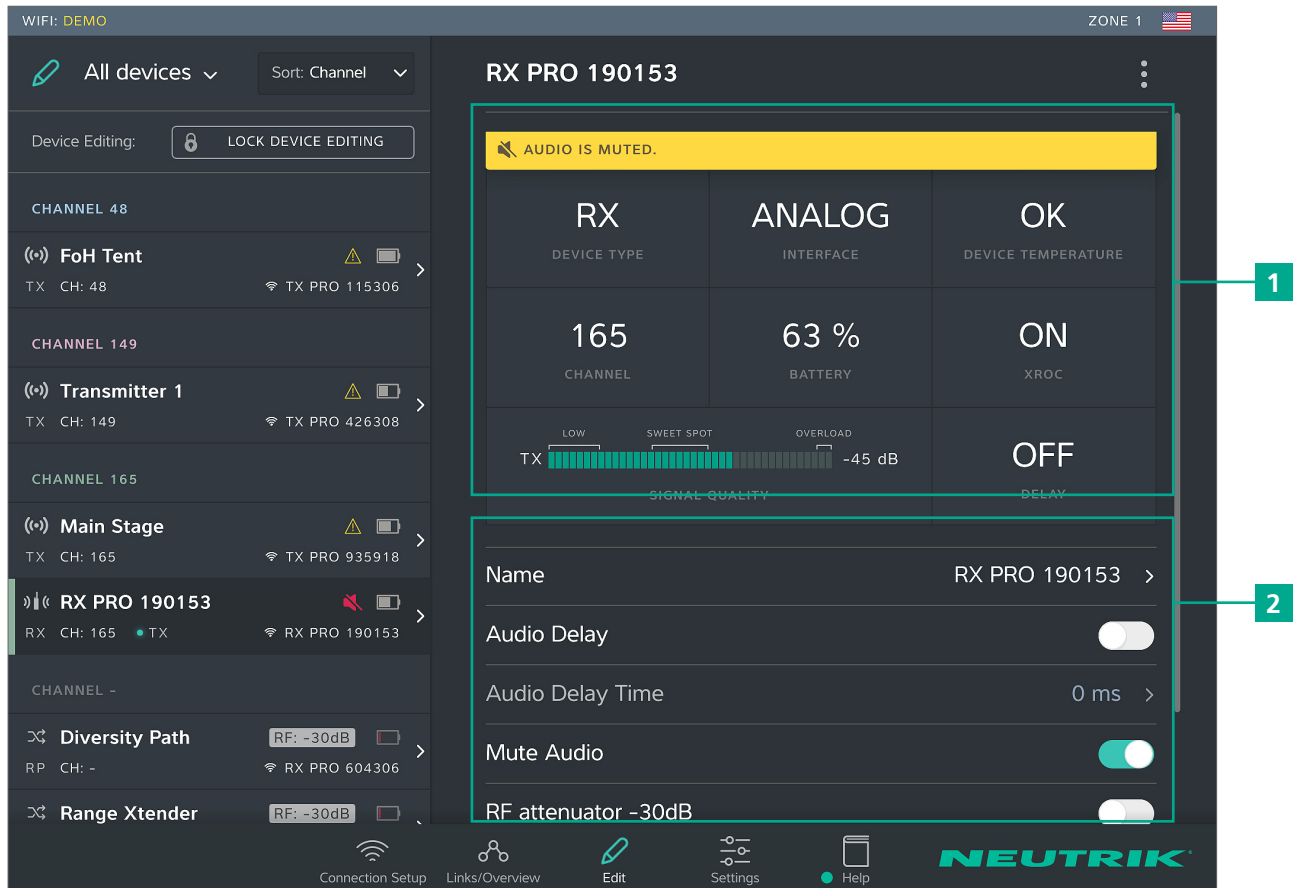

Pos.	Description	Pos.	Description
1	<b>Device properties</b> <ul style="list-style-type: none"> <li><b>Device Type:</b> Indicates that the device is an RX. (for RX with repeater module: RP)</li> <li><b>Interface:</b> Indicates the module being used.</li> <li><b>Device Temperature:</b> Indicates the temperature of the device (low, ok or high)</li> <li><b>Channel:</b> Indicates the channel the device is assigned to.</li> <li><b>Battery:</b> Indicates the battery level in %.</li> <li><b>XROC:</b> Indicates whether the transmission path of the XROC mode is ON/OFF.</li> <li><b>Signal quality:</b> Indicates the signal quality of the signals received from the TX and/or repeater. Signal quality is a combination of RSSI Level and packet loss.</li> <li><b>Delay:</b> Indicates the set delay time in milliseconds, feet or meters, or indicates the delay is off.</li> </ul>	2	<b>Settable properties</b> <p>Tapping on a property opens the associated sub-page.</p> <ul style="list-style-type: none"> <li><b>Name:</b> Opens the page for changing the device name.</li> <li><b>Audio Delay:</b> Tap the button to activate/deactivate the delay.</li> <li><b>Audio Delay Time:</b> Opens the page for setting the delay time.</li> <li><b>RF attenuator -30dB:</b> Attenuates the received RF signal by 30 dB (<a href="#">page 29</a>)</li> <li><b>Mute Audio:</b> Mutes this RX unit</li> <li><b>Info &amp; Settings:</b> Opens a page with information about the device.</li> </ul>

In standalone mode the [Link](#) button is shown on page [Edit](#). Tapping the [Link](#) button links this RX to the TX.

### 4.3.4 Settings page

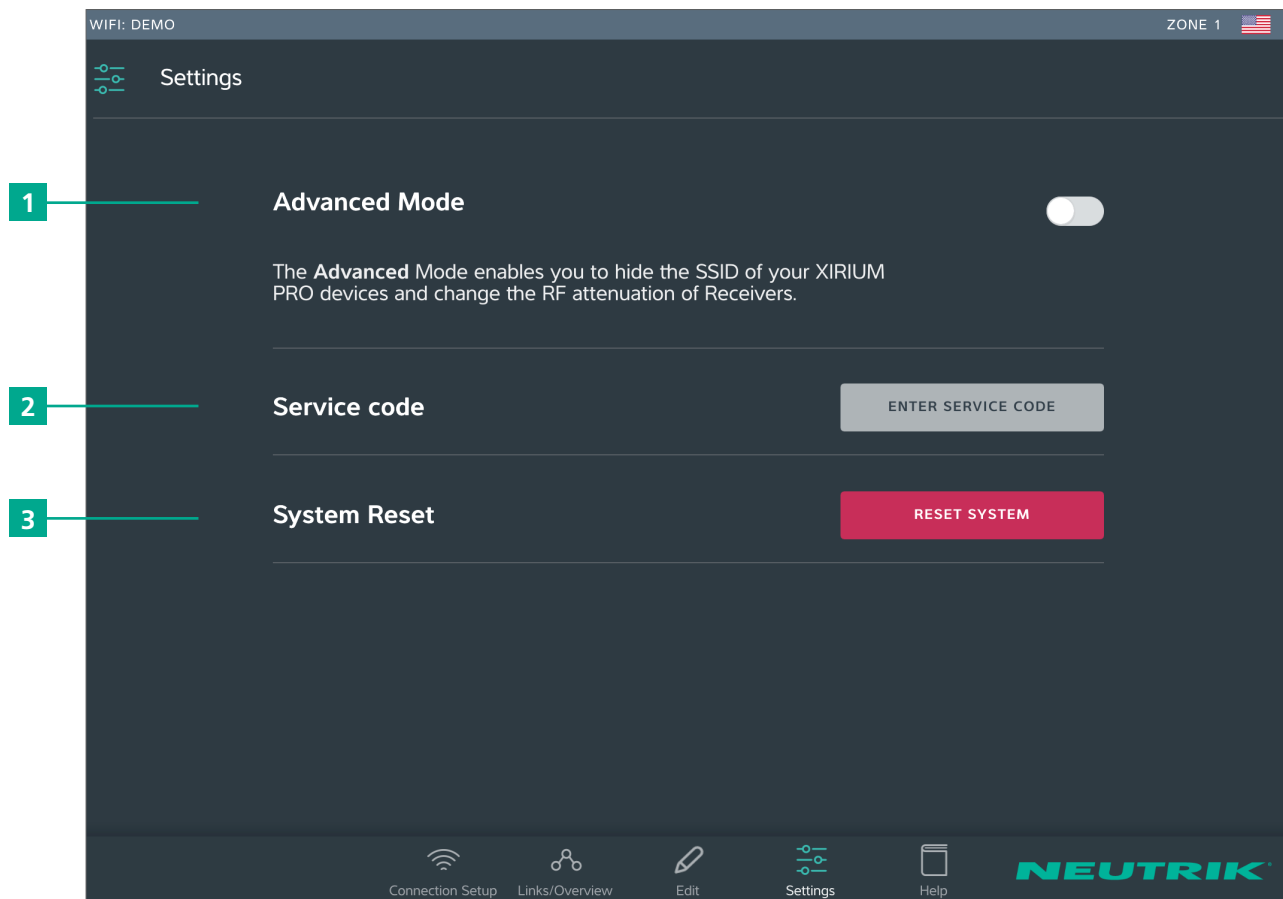

Pos.	Description
1	<b>Advanced Mode</b> Tap the button to activate / deactivate Advanced Mode (page 40)
2	<b>Enter service code button</b> Opens entry field for service code (only for service personnel)

Pos.	Description
3	<b>Reset System button</b> Tapping this button opens a window with reset options.

### 4.3.5 Help page

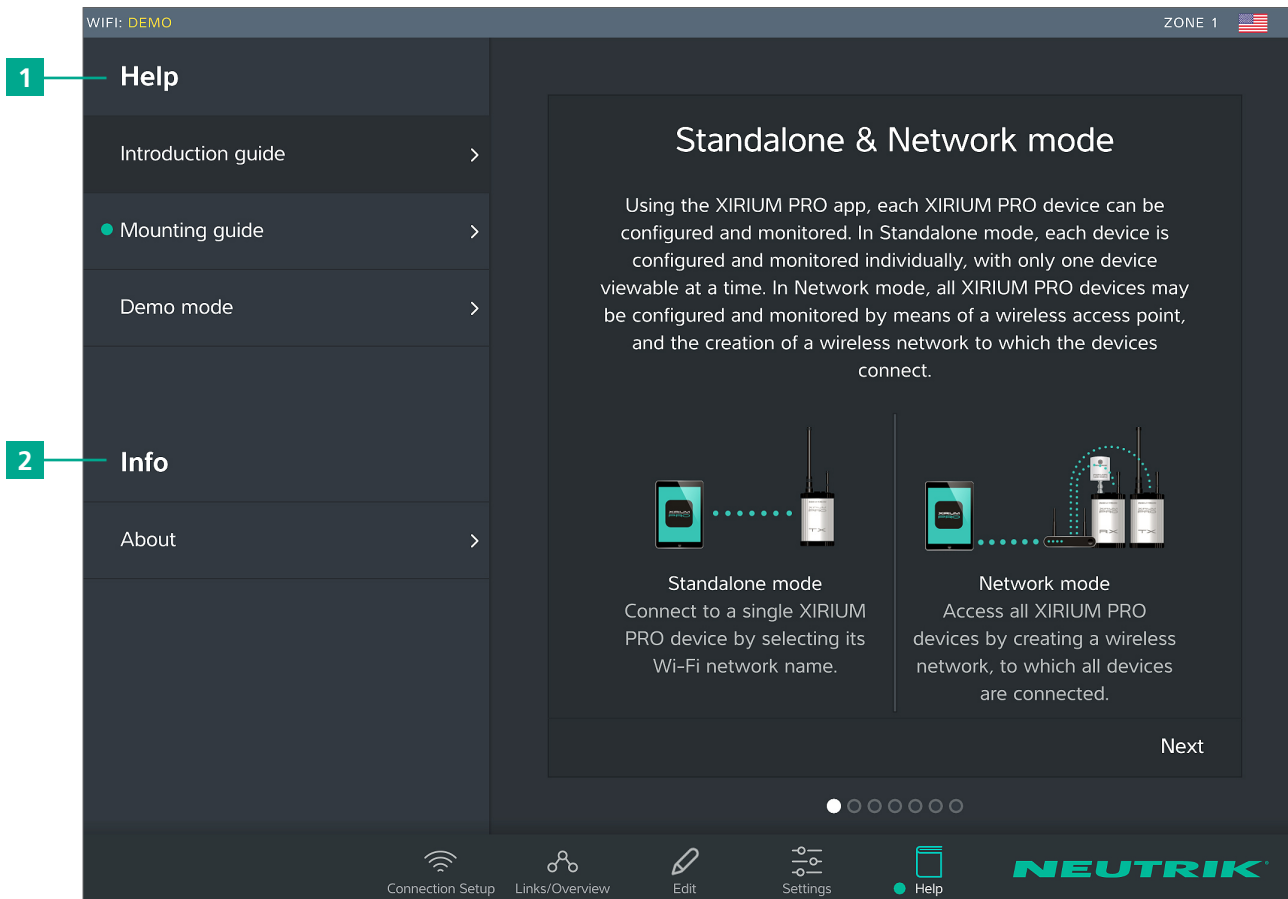

Pos.	Description
1	<b>Help</b> Useful information for a proper XIRIUM PRO setup.
2	<b>Information about the software</b> Software Version: Version of the installed app. Version Date: Date app was issued



## 4.4 Getting started

The XIRIUM PRO system makes it possible to replace conventional cable connections between audio sources and audio sinks (referred to in short as "peripheral devices" below) with a robust radio connection.

With just 2 devices, the transmitter (TX) and the receiver (RX), an audio signal can be transmitted quickly and cost-efficiently. The XIRIUM PRO system transfers audio signals (LINE level) as well as digital audio signals (AES or DANTE) in studio quality with an extremely low latency time.

8 channels in the 5 GHz band are available for transmitting the audio signal. Up to two audio signals can be transmitted in one RF channel with no loss to audio quality. The distance between transmitter and receiver can be more than 3200 feet. The actual distance between transmitter and receiver depends on the specific environmental conditions (line of sight, obstacles in the link, reflections, external RF signals, etc.).

Depending on the distance between transmitter and receiver, the transmission power may be manually controlled using the associated app in order to ensure the RSSI level remains in the "green range". In order to be able to establish a connection between TX and RX, the devices must be separated by a distance of at least 10 feet (using 6 dBi antenna and transmission power set to -3 dB).

	Channel	Medium frequency
UNII-1 band	Ch 40	5200 MHz
	Ch 44	5220 MHz
	Ch 48	5240 MHz
UNII-3 band	Ch 149	5745 MHz
	Ch 153	5765 MHz
	Ch 157	5785 MHz
	Ch 161	5805 MHz
	Ch 165	5825 MHz

The XIRIUM PRO system has been designed with features to simplify use. Understanding these features will be helpful before the system is put into operation.

### 4.4.1 App

The app is the central control interface of the XIRIUM PRO system. Using the app, transmission paths and networks can be created and managed. The app provides information about the current status of the connected devices and transmission paths. The XIRIUM PRO devices can be connected to the app through 2 modes:



#### Network mode

Several devices connected to the app via an access point.

#### Stand-alone mode

Only 1 device is directly connected to the app.

**i** It is highly recommended to choose a 2.4 GHz channel according to prior agreement with event management. Uncoordinated usage of the 2.4 GHz channel may lead to connectivity issues in the 2.4 GHz transmission path due to high traffic. The audio transmission is not affected by the 2.4 GHz transmission path!

### 4.4.2 Repeater

A "repeater" is an RX equipped with a repeater module. The repeater is used in the following situations:

- Stabilizing transmission paths  
The repeater receives the signal from the TX and transmits a redundant signal to the RX. The redundant signal stabilizes the connection and reduces efforts caused by interferences.
- Overcoming obstacles  
If no line-of-sight connection is possible, obstacles such as walls, glass or even corners can be overcome with the repeater.
- Extending distances  
When a repeater is used, the distance between TX and RX can be doubled.

### 4.4.3 Signal quality bar

The signal quality bar displays both RSSI level and packet loss. The scale of the bar refers to the RSSI level (Received Signal Strength Indicator). It is recommend to have an RSSI level not appearing in the "low" and "overload" area. The 5 Ghz chip has its best performance between the range of -60 dB to -50 dB, which refers to the sweet spot zone in the app.

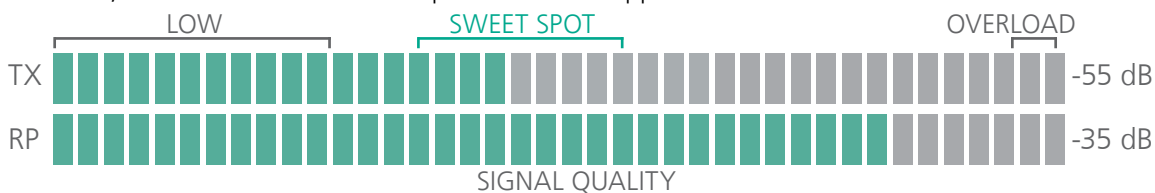

The color of the bar displays the packet loss:

- Bar is displayed **green**: packet loss is low
  - Bar is displayed **orange**: packet loss is critical
  - Bar is displayed **red**: packet loss is high.
- A high packet loss increases the probability of losing audio.

## Examples

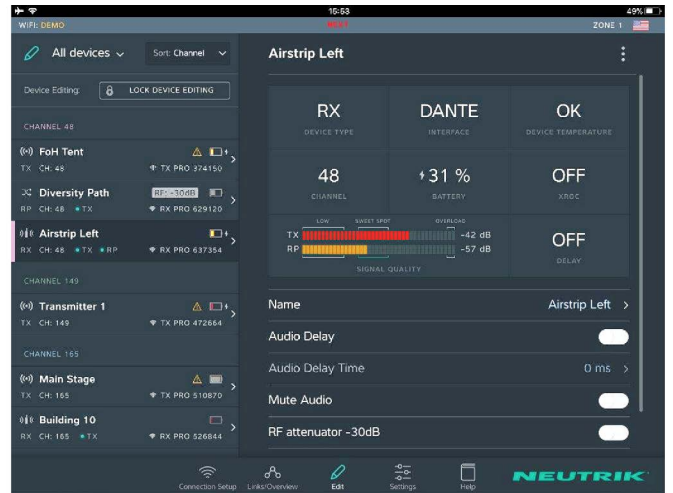
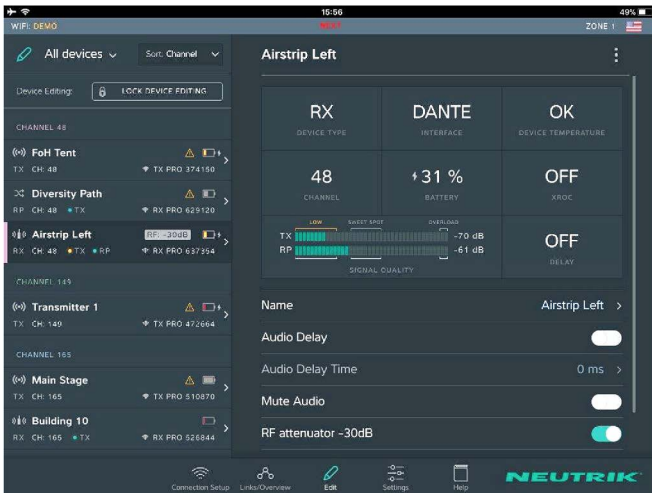

- RSSI level received from the TX is critical.
- The packet loss received from TX and RP is low.  
We recommend to increase the transmission power of the TX.

- RSSI level received from TX and RX are OK
- The color of the bars indicate a high (TX) and a critical (Repeater) packet loss.  
We recommend to relocate the devices and / or change the RF channel.

**i** An improper RSSI level can be modified by increasing or decreasing the transmission power.

**i** If the packet loss is high, the position of the devices have to be modified. Double-check if there are other devices operating on the some channel and change the RF channel.

### 4.4.4 Transmission power

Depending on the application, the transmission power should be adjusted with the app so the RSSI level on the receiver remains in the recommended range. However, the 10-foot minimum distance between the TX/RX must always be maintained. This minimum distance applies when the 6 dBi antenna and a transmission power of -3 dB are used. If the 9 dBi antenna and/or a higher transmission power are used, the minimum distance increases.

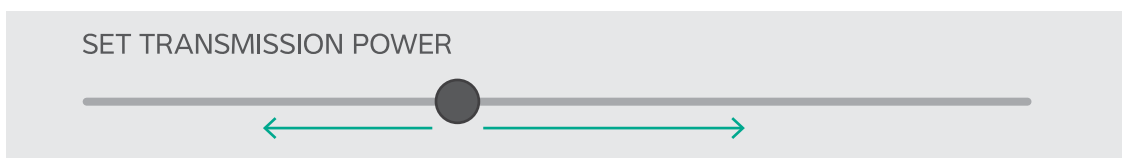

**Decreasing transmission power**  
In indoor areas and over short distances.

**Increasing transmission power**  
In outdoor areas and over longer distances.



### 4.4.5 XROC mode

If only 1 audio signal per RF channel is needed, we recommend using XROC mode. XROC stands for "Extreme Ruggedized One Channel". In XROC mode, only 1 audio signal at 6 Mbit/s is available for each RF channel. The connection between the devices is much more stable in XROC mode, because external influences do not interfere with the RF signal between the XIRIUM PRO devices as much. External influences include strong reflections of the RF signal in a room or from buildings, or external signals. The power consumption of the devices is higher in XROC mode.

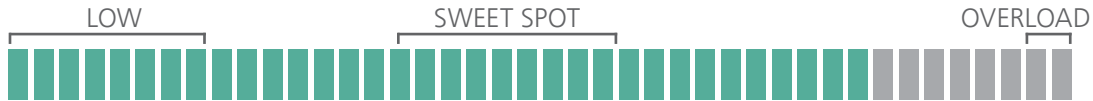

The increase in the performance range is illustrated in the RX signal quality bar, which displays a smaller "low" area when XROC mode is used.

**i** If XROC mode is enabled on a TX, only audio channel 1 is being transmitted. Therefore a linked RX will have no audio on channel 2.

### 4.4.6 Antennas

XIRIUM PRO uses omnidirectional antennas with fixed vertical radiating angles. Neutrik offers two different antennas: the standard 6 dBi antenna, featuring a 25° vertical angle, and an optional 9 dBi antenna with a 12.5° vertical angle.

**6 dBi**

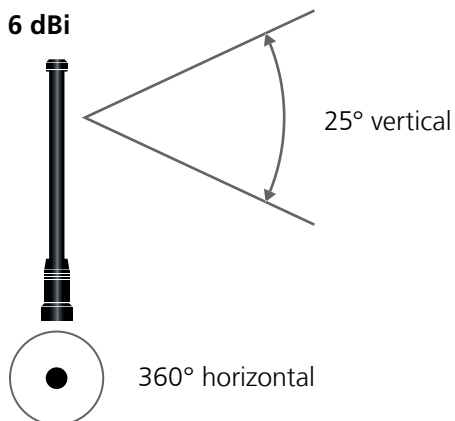

For transmitter and repeater!

**9 dBi**

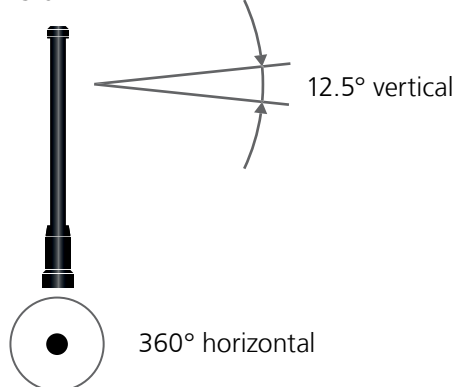

For transmitter and repeater!

Using a 9 dBi antenna brings a gain increase of 3 dB, which doubles the transmission power.

**14 dBi**

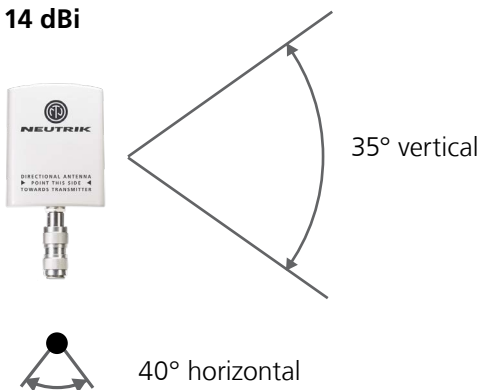

For pure receivers!

For pure receivers Neutrik recommends to use a directional antenna. It helps focusing on the TX signal and avoids disturbances from other systems. There's an N-type adapter provided with the antenna to mount it directly on the device.

### 2 dBi



360° vertical

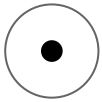

360° horizontal

The 2 dBi omnidirectional antenna should be used for applications where a parallel alignment of the TX - RX antenna on the same height can't be established.

Due to a lower antenna gain, the transmission range is less.

For receiver with a repeater module inserted!

### Not correct positioning

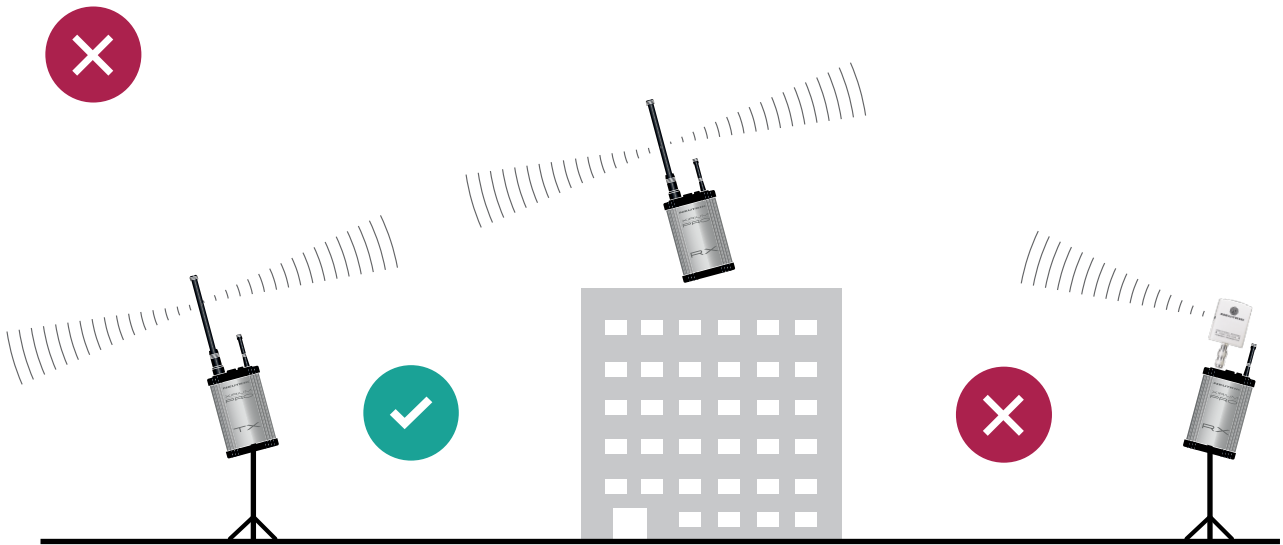

### Correct positioning

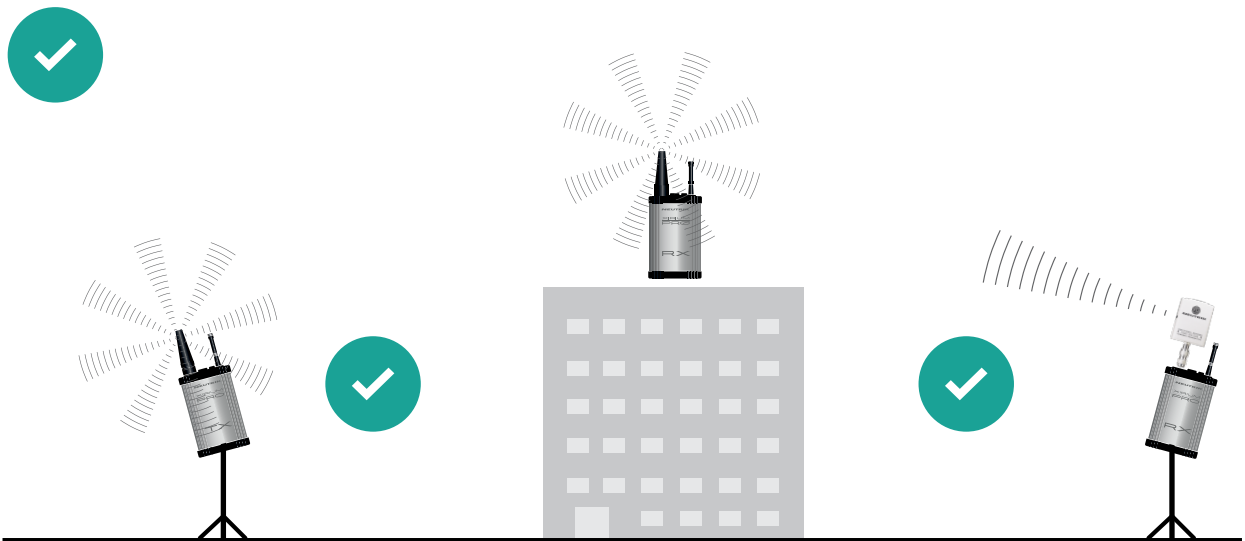

#### 4.4.7 Remote antennas

If the 5 GHz antenna and the 2,4 GHz antenna need to be aligned differently in terms of angle, it's advisable to remote the 5 GHz link. For that purpose Neutrik offers an antenna cable (NKXPA-5) with a length of 5 meters and an attenuation of 4 dB. There is also an additional directional antenna available for such applications having a gain of 18 dBi. This antenna must be used only for pure receivers and not for any transmitting device, hence also not for a repeater. Like all other XIRIUM PRO antennas this antenna has a vertical polarization. It is necessary to gear this antenna in the correct angle towards the TX antenna. A correspondent graphical indication can be found on the backside of the antenna.



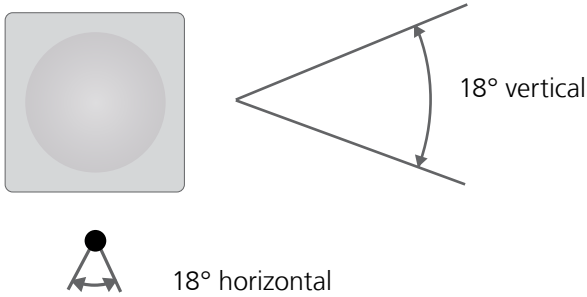

##### 18 dBi (NXPA-18-18-18)



For pure receivers as a remote antenna.

#### 4.4.8 Antenna combinations

These are possible antenna combinations for the XIRIUM PRO system:

 <p>• NXPA-6-360-25 or NXPA-9-360-12.5</p>	 <ul style="list-style-type: none"> <li>• common setup</li> <li>• point-to-multipoint</li> </ul>
 <p>• NXPA-6-360-25 or NXPA-9-360-12.5</p>	 <ul style="list-style-type: none"> <li>• setup with directional antenna on RX</li> <li>• point-to-multipoint</li> <li>• Focusing on the TX signal and avoid disturbances from other systems</li> </ul> <p>• NXPA-14-40-35</p>

- NXPA-6-360-25  
or NXPA-9-360-12.5
- NKXPA-5  
• NXPA-14-40-35
- NKXPA-5  
• NXPA-18-18-18

- remote setup on RX
- point-to-multipoint
- different alignment of 2,4 GHz- and 5 GHz antenna required

- NKXPA-5  
• NXPA-N-FF  
• NXPA-6-360-25  
or NXPA-9-360-12.5
- NKXPA-5  
• NXPA-14-40-35
- NKXPA-5  
• NXPA-18-18-18

- remote setup on TX + RX
- point-to-multipoint
- Option to mount the antennas outdoor and keep the devices indoor due to temperature reasons (< 0°C / > 50°C)
- Shorter range than with the other setups

**i** For a remote setup of the TX antenna an adapter (NXPA-N-FF) is required.

**Transmitter**

**Repeater**

**Note!**

**Due to RF regulations it's not allowed to use the directional antennas on a transmitter or repeater!**

#### 4.4.9 Line-of-sight and redundant RF path

For a reliable wireless audio link, make sure all XIRIUM PRO devices have a line-of-sight connection. If a line-of-sight connection cannot be established, the receiver may be in a drop-out zone. A drop-out zone is a point where phase cancellation occurs between the direct signal and the deflected one. Relocating the transmitter (TX) and/or receiver (RX) can help eliminate this phase anomaly. Using a repeater can also eliminate the problem of the drop out zone. A repeater effectively provides a redundant RF path to all receivers within range. The RX receives identical audio signals from both the transmitter and repeater.

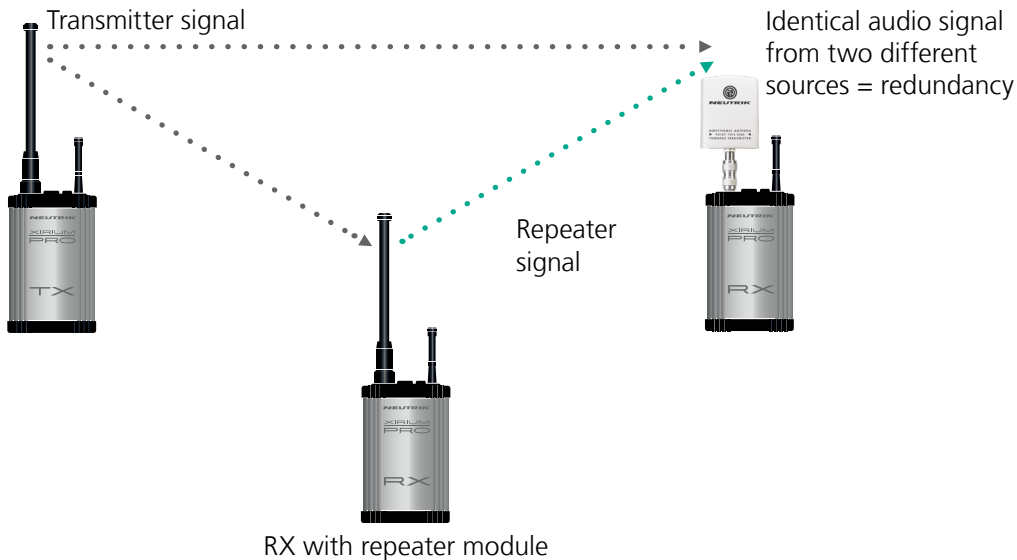

#### 4.4.10 Antenna height + distance

Consider the Fresnel zone, which is an ellipsoidal area between wireless devices. For XIRIUM PRO TX and RX devices, there should be no obstacles within the Fresnel zone. Maintaining proper antenna height is essential to ensure trouble-free communication between XIRIUM PRO devices. To define an area that is free of obstacles, use the following chart to estimate proper antenna height.

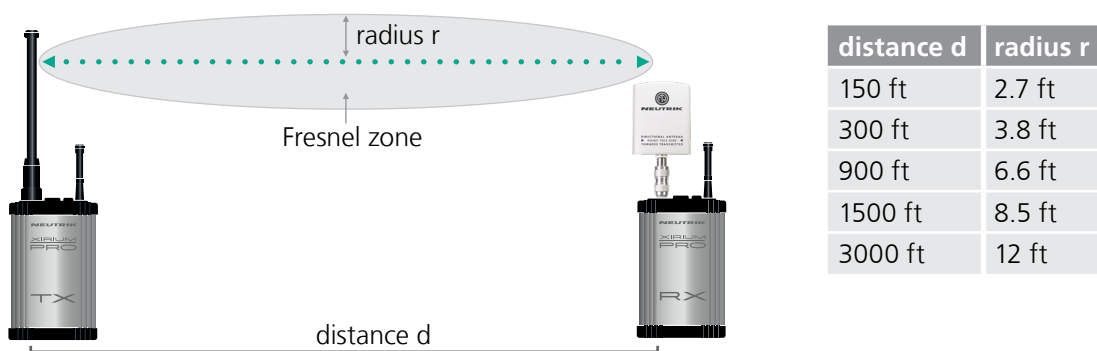

#### 4.4.11 RF attenuator

RF attenuator is a parameter which can be set on each RX only if the Advanced Mode is turned on. It attenuates the RF signal by 30 dB. The RF attenuator works best in combination with an increased transmission power on the TX. An activated RF attenuator increases the signal-to-noise ratio on that RX. Hence on an event with a lot of disturbing signals it is possible to lower the surrounding noise and at the same time increase your transmission power of the TX to establish a better reception.



## 4.5 Selecting transmission channels

### 4.5.1 Automatic selection of transmission channels

A TX is assigned to channel 149 by default. If channel 149 is already occupied by a different TX, the device searches for the next free channel. The TX saves the last channel used. When switched on again, the TX uses the last channel used, as long as it is not occupied. If the TX changes the channel, all devices in the transmission path are assigned to the new channel.

### 4.5.2 Manual selection of transmission channels

The transmission channel can also be manually adjusted with the app. To guarantee a trouble-free process, the app prevents an adjacent channel from being selected. The transmission channel can be changed on the Edit page. More information in Section "Changing the transmission channel" on page 40.

## 5 Operation

### 5.1 Setting devices into operation

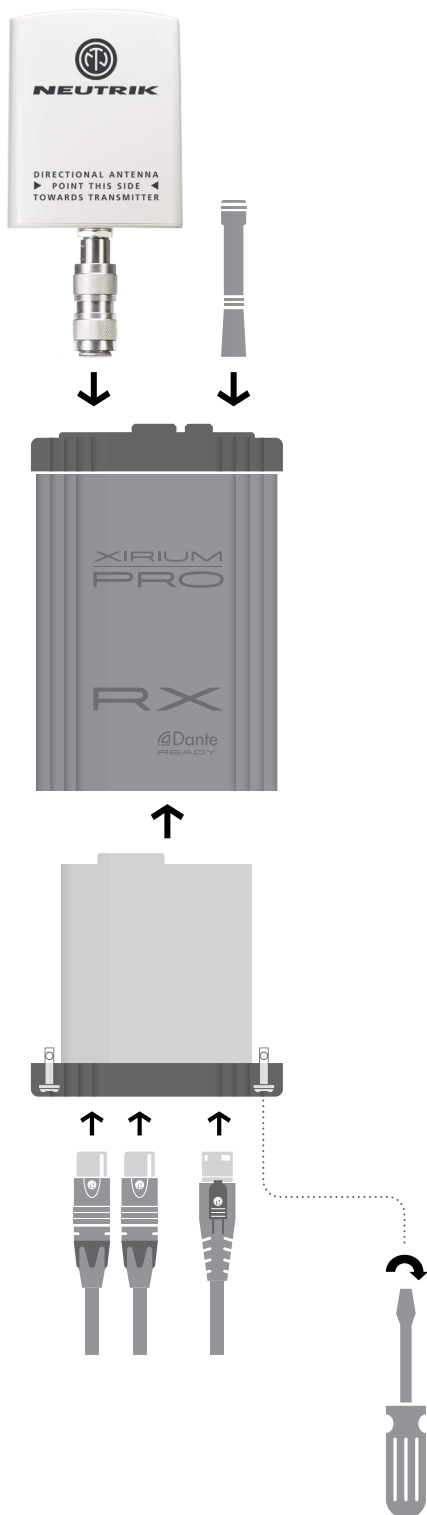

#### Preparation

- ▶ Unpack all parts.
- ▶ Save packaging for later transport and storage.
- ▶ Check the contents of the package for visible damage.
- ▶ When visible damage to the packaging and/or delivered parts is detected:  
Contact the salesperson or Neutrik sales partner.
- ▶ Do not use damaged devices under any circumstances.

#### ⚠ CAUTION



#### Danger of damage to hearing!

Signal peaks may occur when an audio source or sink is connected.

- ▶ Before making connections, mute the signal path of the peripheral devices.

#### Putting together the device

- ▶ Screw the antennas tightly to the base station.
- ▶ Insert the module into the base station.
- ▶ Secure the module in the base station:  
Using a straight screwdriver, turn the locking pin 1/4 rotation.



The XIRIUM PRO system can be used as a signal converter.  
Depending on the module used, an analog signal can be converted to a digital signal, for example.

- ▶ Connect the device to the mains supply with a powerCON TRUE1 plug.  
As soon as the device is connected to the mains supply 500mA will be used to charge the module.



Depending on the application, battery runtime of the device is up to 10 hours.

#### Switching the device ON/OFF

- ▶ Switch the device on:  
Push ON/OFF switch.
- ✓ The device powers up.
- ✓ After about 5 seconds, the power LED lights green.
- ▶ Switch the device off:  
Push ON/OFF switch.



These settings remain saved after the device is switched off:  
TX: Transmission channel, transmission power level, XROC mode  
RX: MAC address of the linked TX, all delay settings, transmission power level (if a repeater)

## 5.2 Setting up the transmission path

It is also possible to set up a simple transmission path without the app. Using the app to set the parameters is recommended.

The following components are needed to set up a simple transmission path:

- ✓ 1 TX with module
- ✓ At least 1 RX with module
- ✓ Optional: 1 RX with repeater module

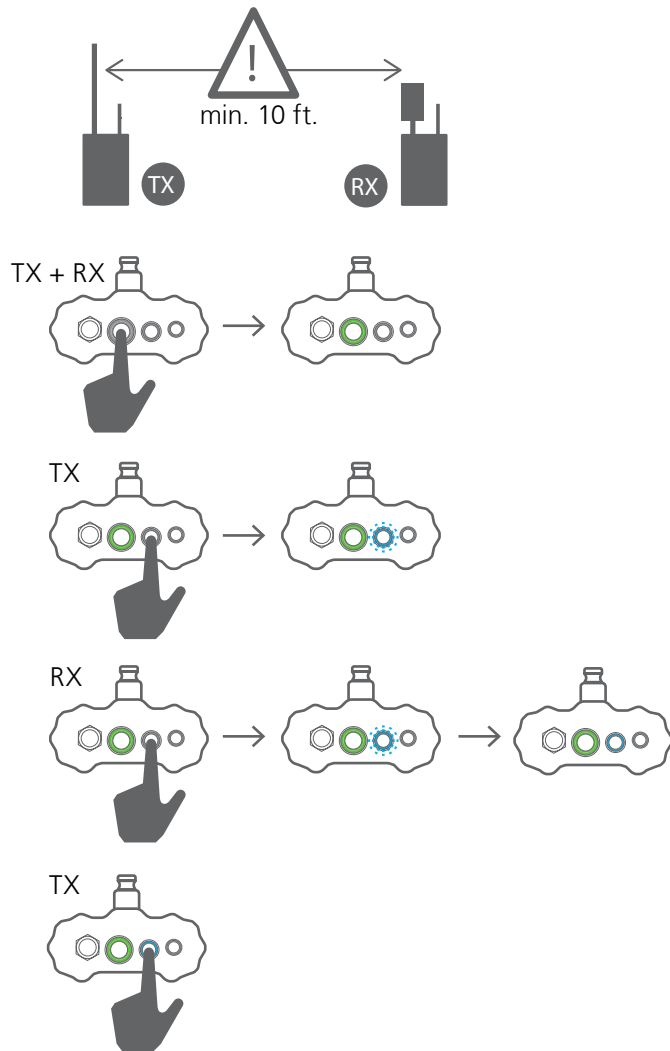

**i** Because of the signal strength, the minimum distance of 10 feet between TX and RX must be maintained for the connection process.

- ▶ Switch on TX and RX.
- ▶ Start the linking process on the TX: Briefly push the link button.
  - ✓ The TX link LED flashes blue.
- ▶ Start the linking process on the RX: Briefly push the link button.
  - ✓ The RX link LED briefly flashes blue.
  - ✓ The RX link LED lights solid blue as soon as the connection to the TX is established.
- ▶ Additional RX devices can be added to the transmission path in the same way.
- ▶ End the linking process on the TX manually: Briefly push the link button.
  - ✓ The TX link LED lights solid blue.

**i** If the linking process is not ended manually on the TX, it is automatically ended after 10 minutes.



## 5.3 Installing and starting the app

The XIRIUM PRO app is available at no cost from the Apple App Store and the Google Play Store.

### 5.3.1 Location Services

Before starting the App, check the Location Services on your device.

#### Apple

▶ Settings - Privacy - Location Services: on

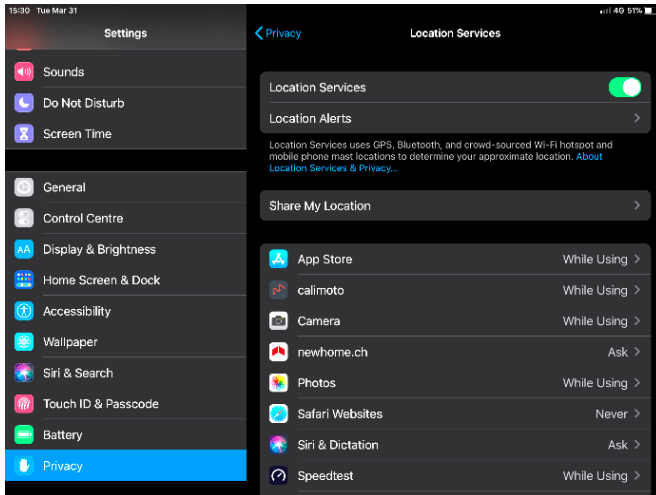

▶ XIRIUM PRO - ALLOW LOCATION SERVICE While Using The App ✓

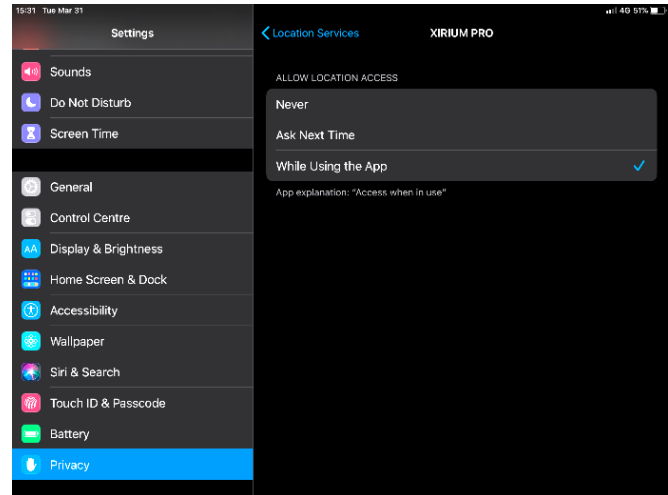

#### Android

▶ Settings - Apps -

XIRIUM PRO -

Permissions

Location: on

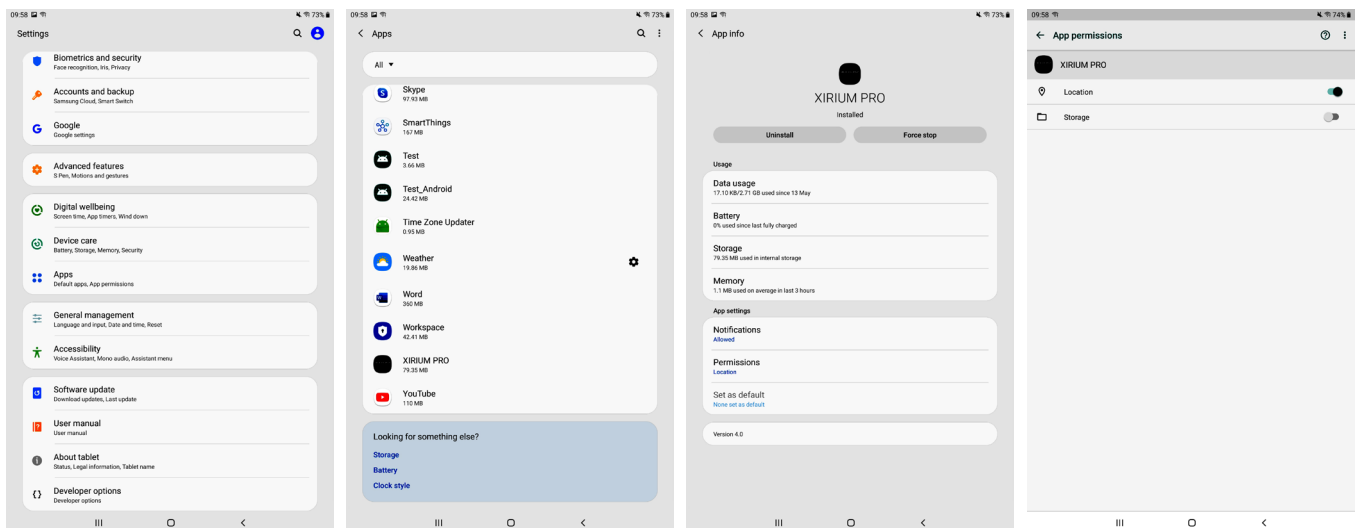

### 5.3.2 Starting the app

Tap the XIRIUM PRO icon.

If the tablet device is set correctly, the app will start so please continue with the connection setup (5.4)

- ▶ If there is a wrong setting on the used tablet device, a popup window occurs. Click "Allow While Using App" and continue with the connection setup (5.4)
- ▶ If there is still a wrong setting on the used tablet device, a red warning message is seen at the bottom. Please go back to 5.3.1

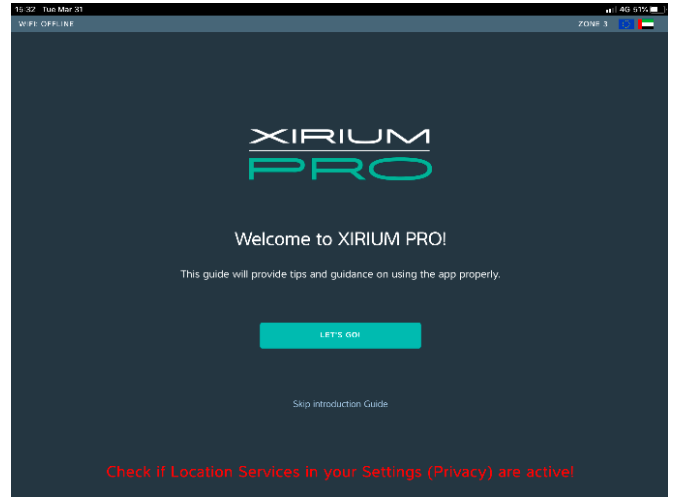
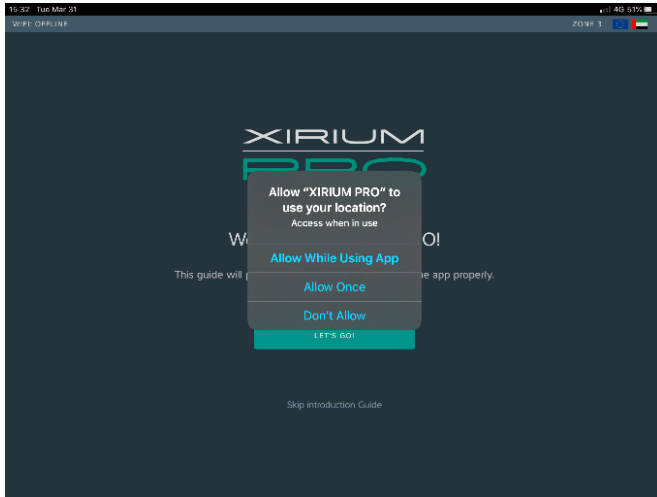

The Introduction Guide is displayed when the app is started. This guide provides a quick overview of the XIRIUM PRO system.

The Introduction Guide can be called up through the [Help](#) page at any time.

## 5.4 Connecting devices with the app

Each device has its own SSID name and its own WLAN password.

The SSID name and WLAN password are found on the type plate inside each device and on the warranty card.

### 5.4.1 Connecting devices in stand-alone mode

In stand-alone mode, the XIRIUM PRO device is connected directly with the app.

- The app is installed on the iPad/Android tablet.

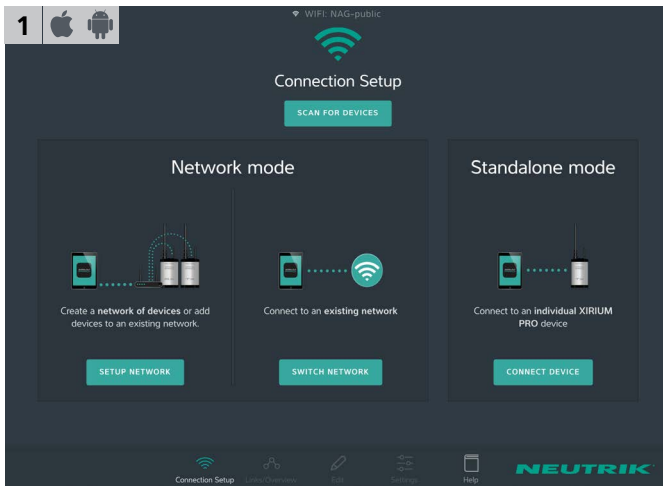

- ▶ Start the XIRIUM PRO app.
- ✓ The Connection Setup page appears.
- ▶ Under **Standalone Mode**, tap **Connect Device**.

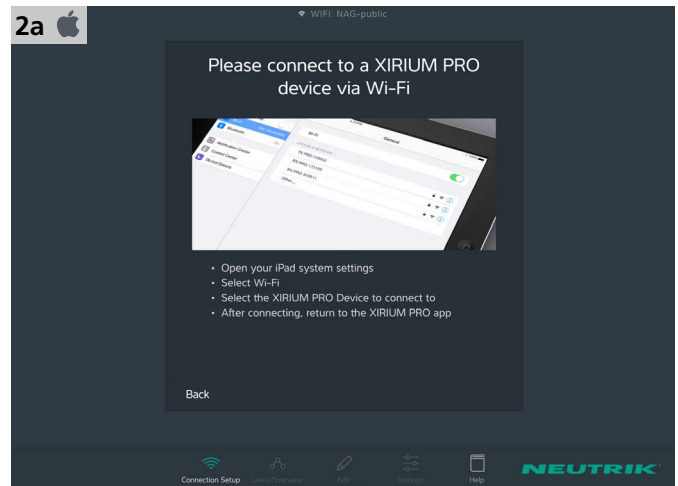

- ▶ Exit the app.
- ▶ On the iPad, open **Settings > WLAN**.
- ▶ Connect the iPad with the XIRIUM PRO device.
- ▶ Switch back to the app.
- ✓ The app connects to the device.

**i** If the device does not appear in the WLAN list its SSID might be hidden. Select "Other" and type in the device's connection details manually.

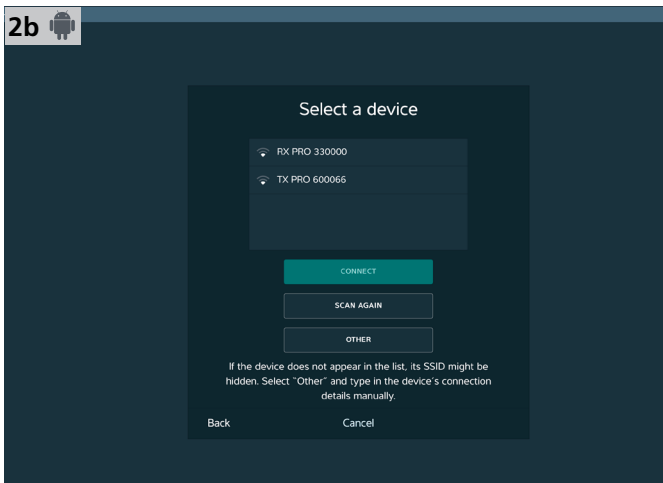

- ▶ Select the XIRIUM PRO device from the selections.
- ▶ Tap the **Connect** button.
- ✓ The app connects itself with the selected device.

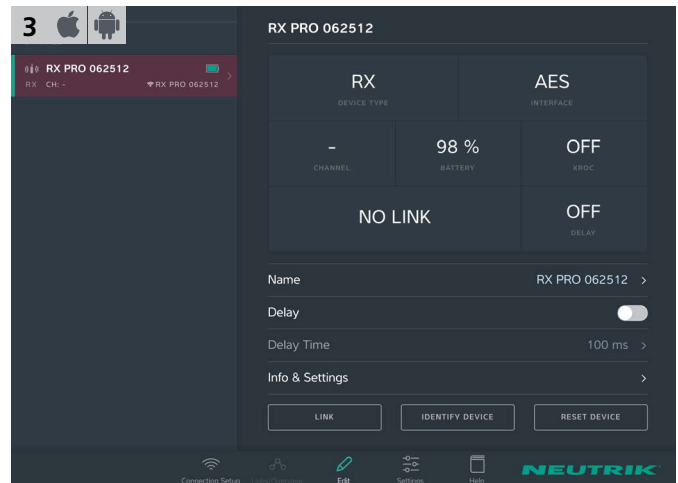

- ✓ The device is connected in standalone mode.

✓ The XIRIUM PRO device is switched on and ready to operate.

### 5.4.2 Connecting devices in network mode

In network mode, the XIRIUM PRO devices are connected to the app via a WLAN access point. The transmission paths are set up and configured with the app.

- ✓ The app is installed on the iPad.
- ✓ The XIRIUM PRO devices are switched on.
- ✓ A 2.4 GHz WLAN access point is available and ready to operate.

**i** WLAN access points, which work in both the 2.4 GHz and the 5 GHz band ranges, are disrupted by the signal of the XIRIUM PRO devices in the 5 GHz range.

- ▶ Therefore, deactivate the 5 GHz band range on the access point.
- ▶ Please observe the details in chapter "8.2 Access point settings" on page 55.

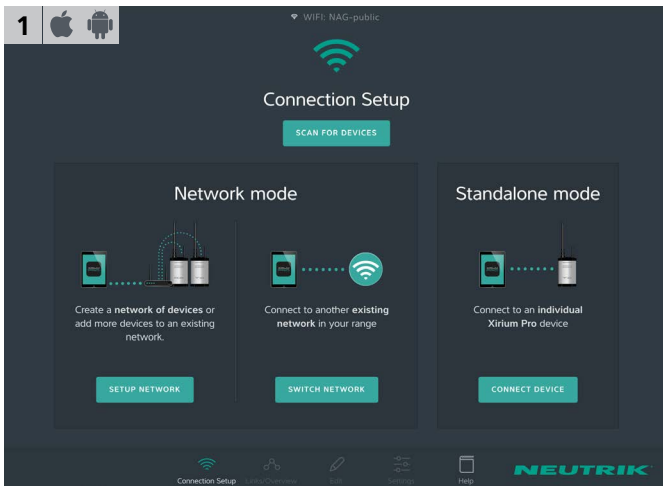

- ▶ Start the wizard:  
Under **Network mode**, tap **Setup Network**.

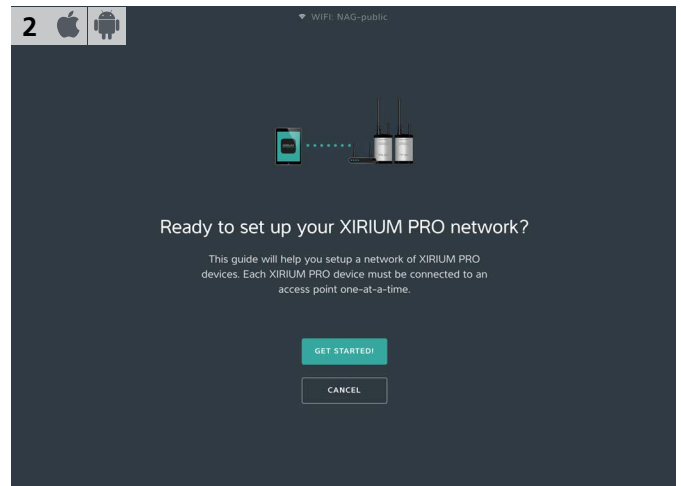

- ▶ Set up network:  
Tap **Get Started!** button.

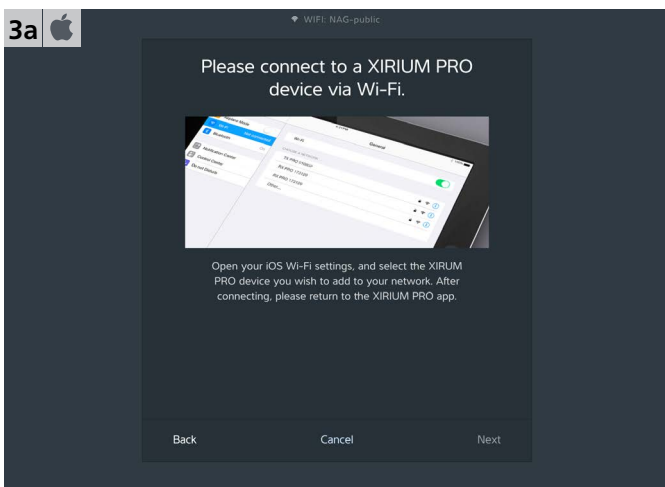

- ▶ Exit the app.
- ▶ On the iPad, open **Settings > WLAN**.
- ▶ Connect the iPad with the XIRIUM PRO device.
- ▶ Wait for the tick after selecting a device before returning to the app.
- ▶ Switch back to the app.

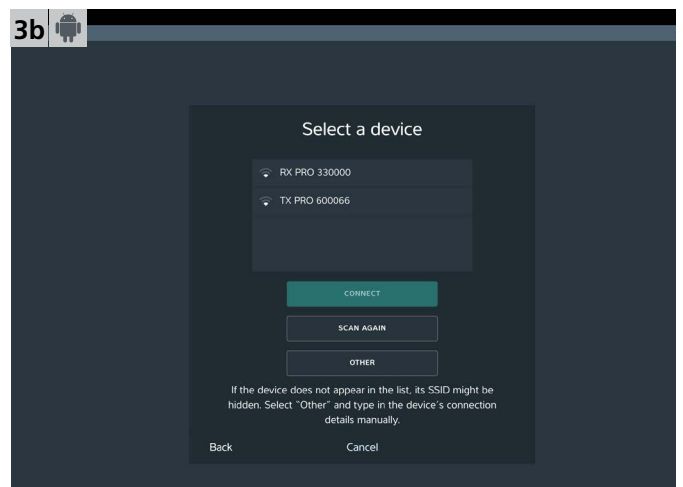

- ▶ Select the XIRIUM PRO device from the selections.
- ▶ Tap the **Connect** button.
- ✓ The app connects itself with the selected device.

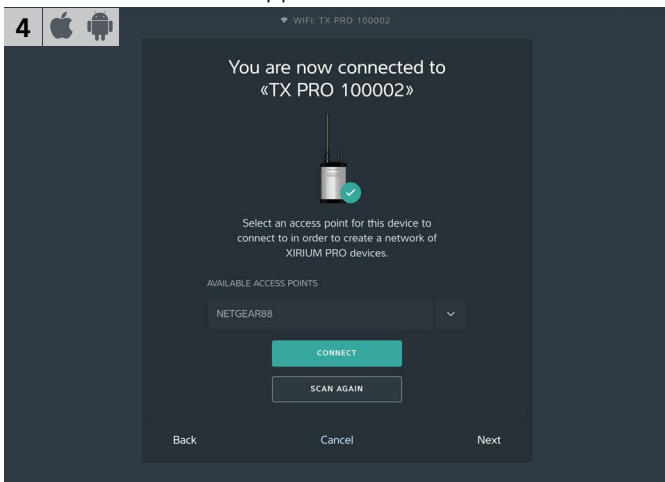

- ✓ The app searches for available access points.
- ▶ Select the access point **Available Access Points** from the drop-down menu.
- ▶ Tap the **Connect** button.



- ▶ Enter the WLAN password of the access point.
- ▶ Tap the **Connect** button.



- ▶ If password is incorrect:  
Tap **Enter Password Again** button.

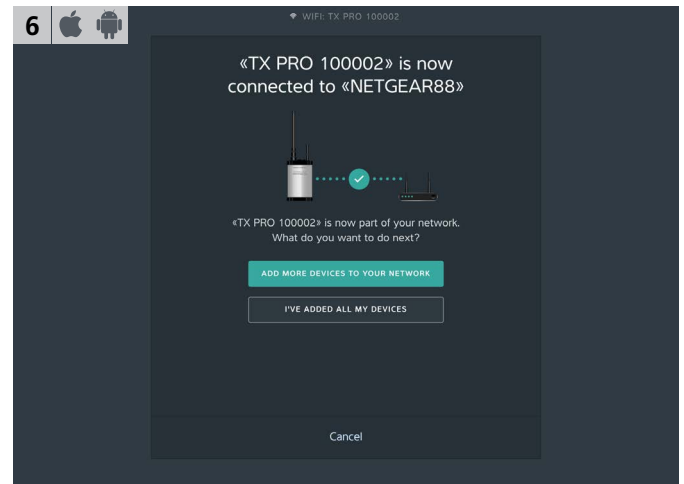

- ✓ The device is connected with the access point.  
Add additional device:  
▶ Tap the **Add More Devices To Your Network** button.

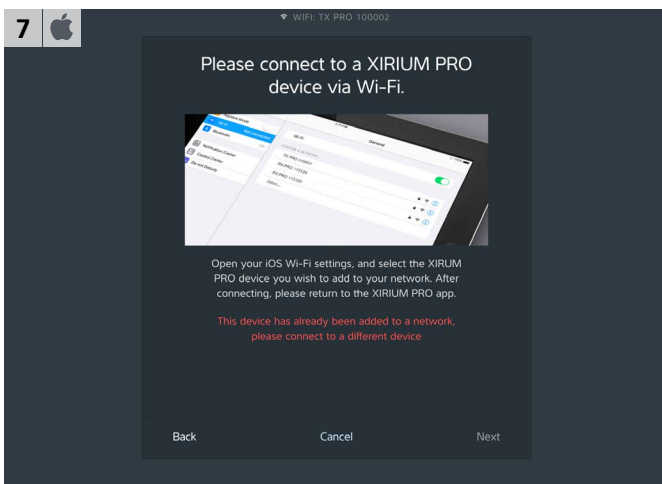

- ▶ Exit the app.
- ▶ On the iPad, open **Settings > WLAN**.
- ▶ Connect the iPad with the XIRIUM PRO device.
- ▶ Switch back to the app.

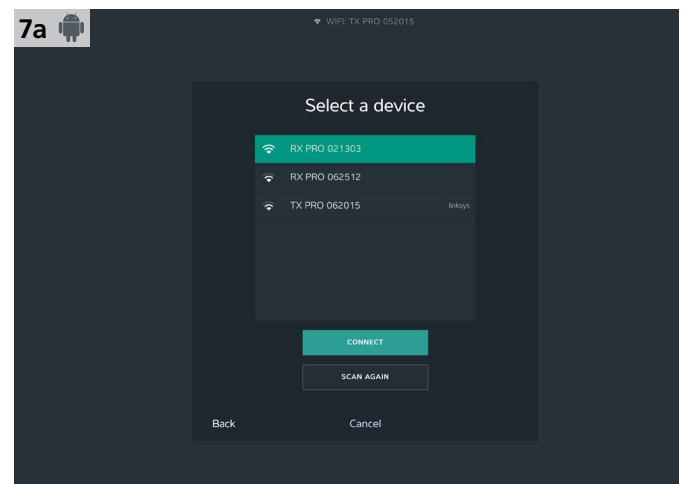

- ▶ Select the XIRIUM PRO device from the available devices.
- ✓ Tap the **Connect** button. The app connects itself with the selected device.

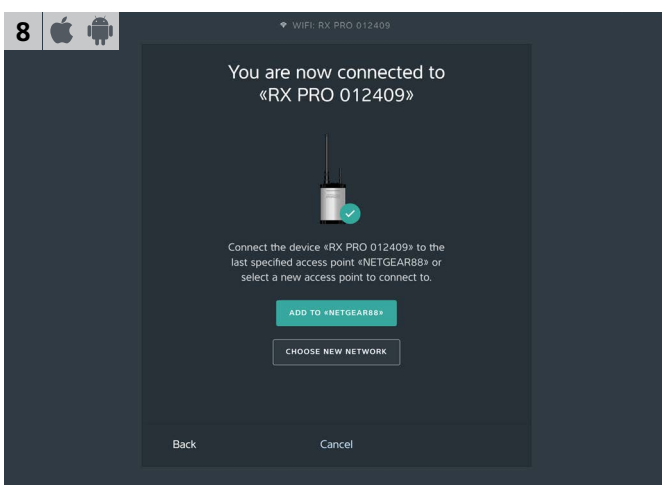

- Add a device to the network:  
▶ Tap **Add to «Access Point Name»** button.
- Add a device to a new network:  
▶ Tap the **Choose New Network** button.
- ▶ Continue with step 3.

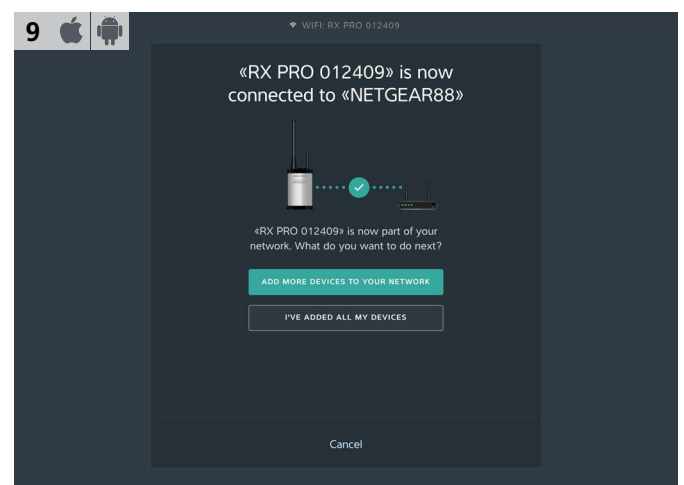

- ▶ Add additional devices to the network:  
Tap the **Add More Devices To Your Network** button.
- ▶ After all devices have been added:  
Tap the **I've added all my devices** button.

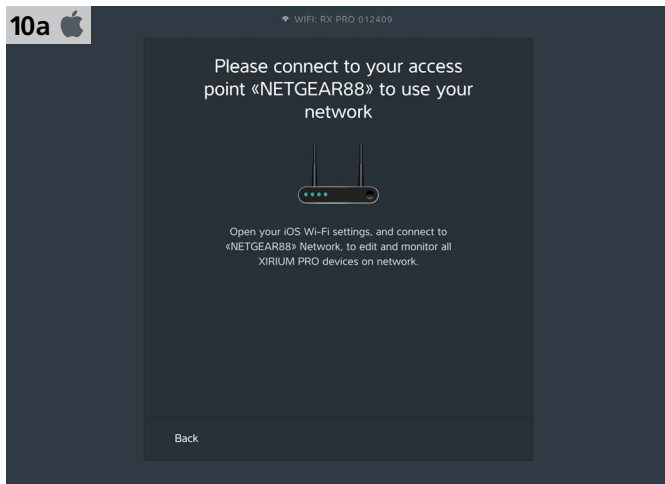

- ▶ Exit the app.
- ▶ On the iPad, open [Settings](#) > [WLAN](#).
- ▶ Connect the iPad with the access point.
- ▶ Switch back to the app.
- ✓ The network has been set up.

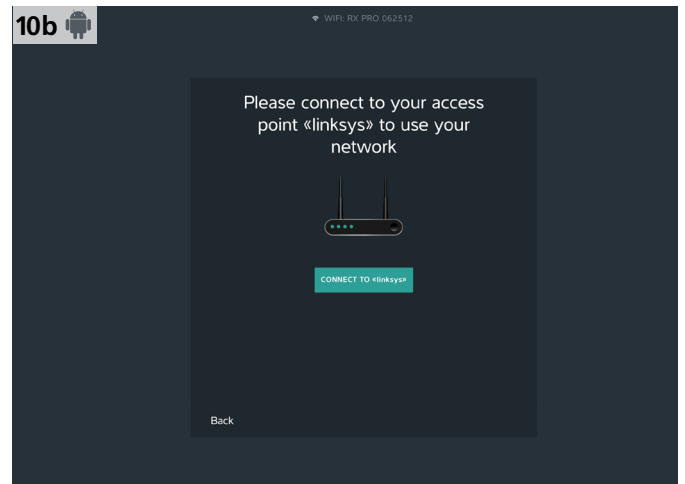

- ▶ Connect tablet to access point:  
Tap Connect to «Access Point Name» button.
- ✓ Tablet connects itself with access point.
- ✓ The network has been set up.

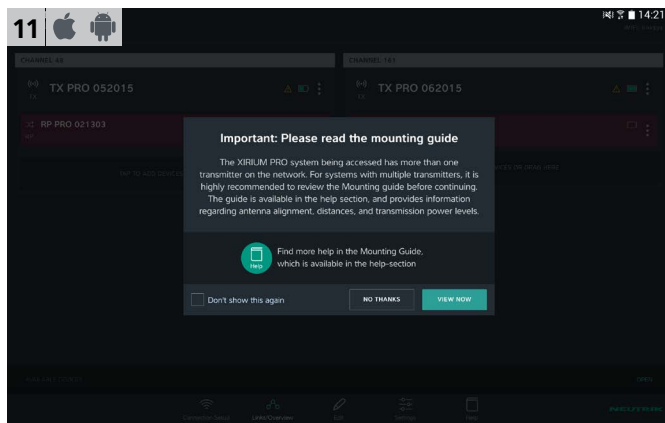

- ✓ If several TXs are connected with the app:  
Reference to the Mounting Guide opens.

**i** Additional devices can be added at any time through the [Connection Setup](#) page.

## 5.5 Arranging the radio transmission path

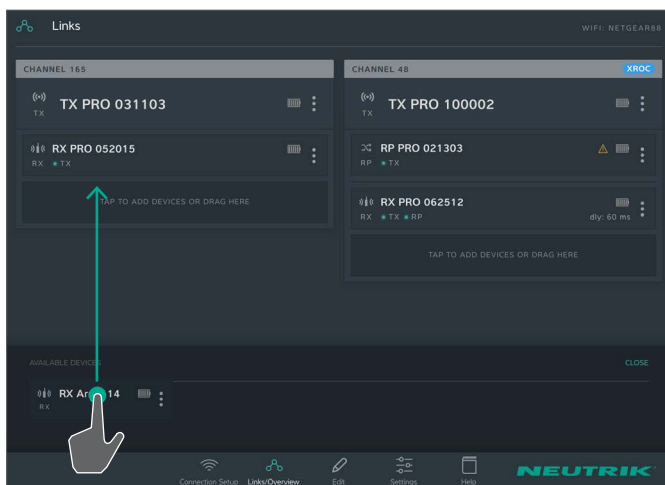

- ▶ Add an available device to a transmission path:  
Under [Available Devices](#), use drag&drop to add the device to the transmission path.

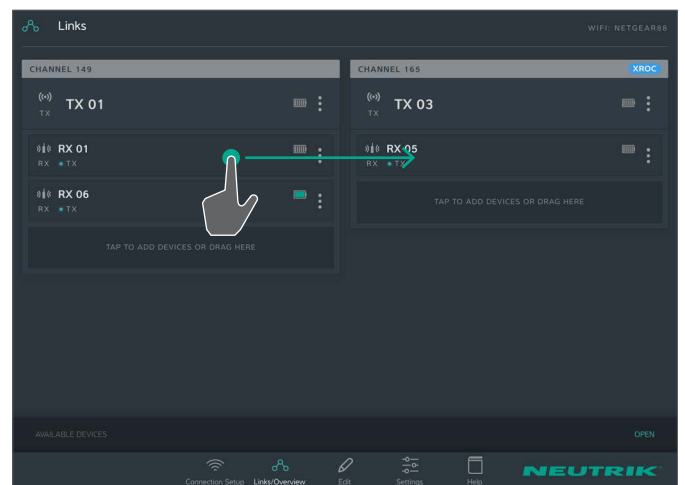

- ▶ Add a device to a different transmission path:  
Tap the device and drag it to the desired transmission path.

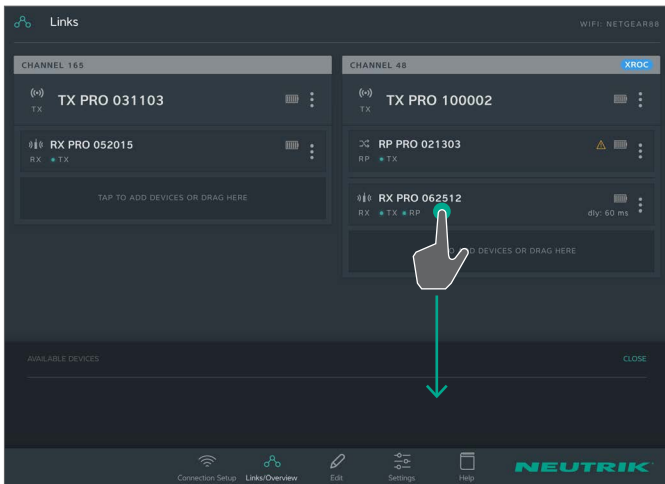

- ▶ Remove a device from a transmission path:  
Tap the device and drag it to **Available Devices**.

## 5.6 Configuring the device parameters

The devices are mainly controlled through the app.

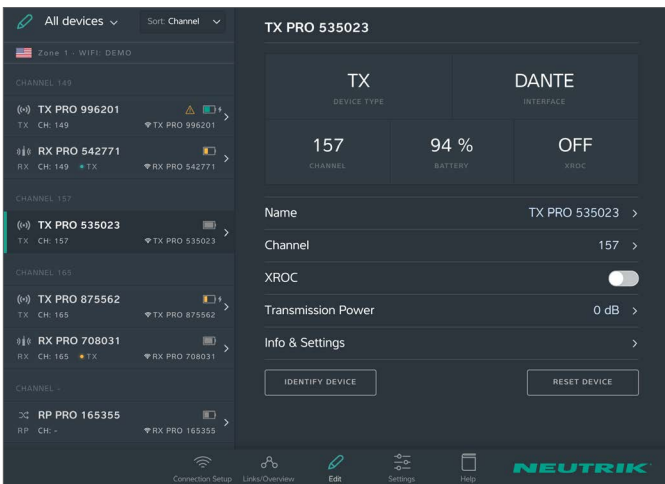

### Selecting the device to edit

- Option 1:  
▶ Tap the device on the **Links/Overview** page.
  - Option 2:  
▶ On the **Links/Overview** page, tap **:** at the device.  
▶ In the options menu, tap **Edit**.
  - Option 3:  
▶ On the **Edit** page, select the device from the list.
- ✓ The device is selected on the **Edit** page.

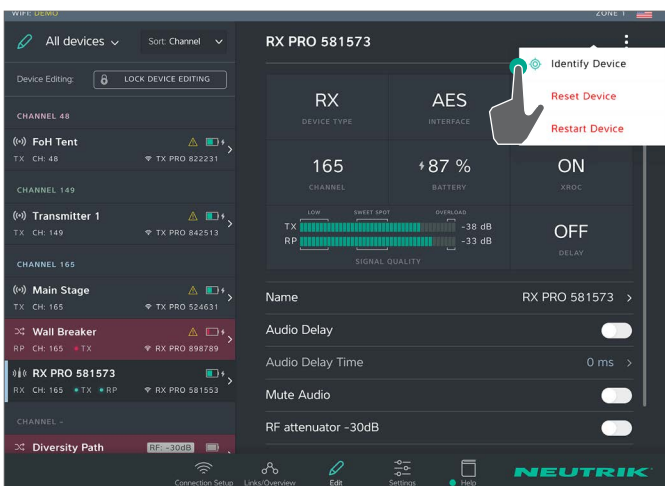

### Identifying the device via the app

- Option 1:  
▶ On the **Edit** page, tap **:** above the monitor section of the selected device.  
▶ In the options menu, tap **identify device**.
- Option 2:  
▶ On the **Links/Overview** page, tap **:** at the device.  
▶ In the options menu, tap **Identify device**.

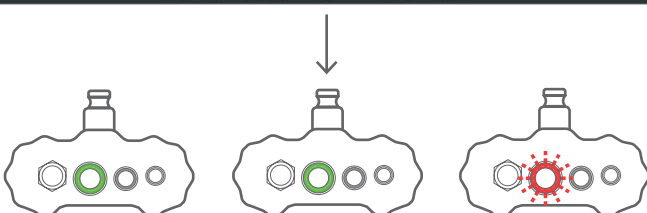

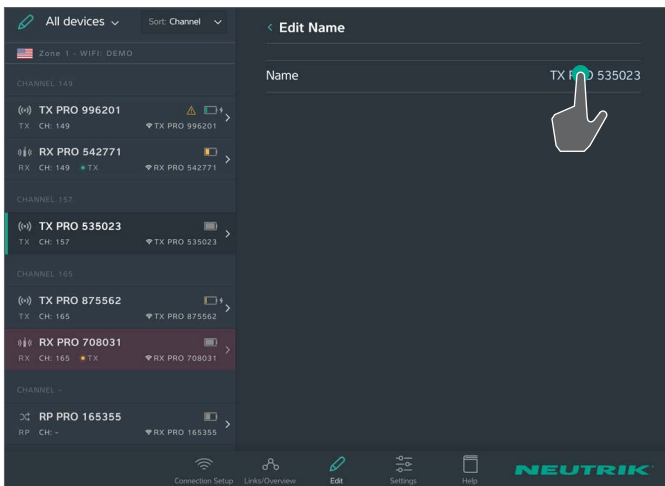

### Changing device names

- ▶ On the **Edit** page, tap the line **Name**.
- ▶ On the **Edit Name** page, tap the device name.
- ✓ The entry keyboard appears.
- ▶ Enter the new name and confirm it.
- ▶ Back to the overview: Tap **< Edit Name**.

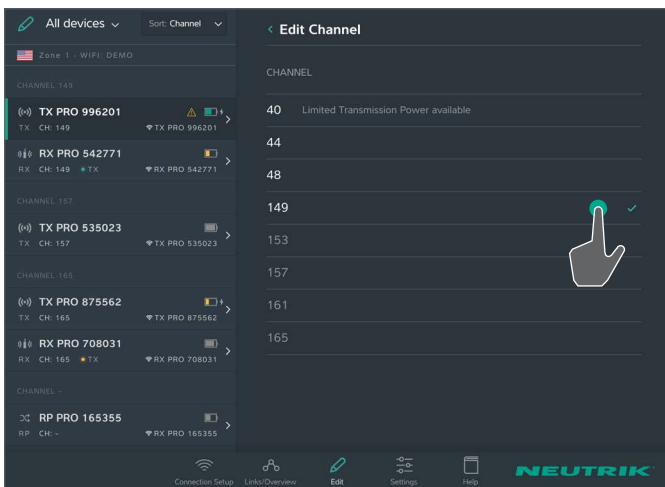

### Changing the transmission channel

The transmission channel can only be set for one TX channel. Occupied or inactive channels cannot be selected and are displayed in gray text. The active channel is marked with ✓.

- ▶ On the **Edit** page, tap the line **Channel**.
- ▶ Tap the desired channel number.
- ✓ The selected channel is marked with ✓.

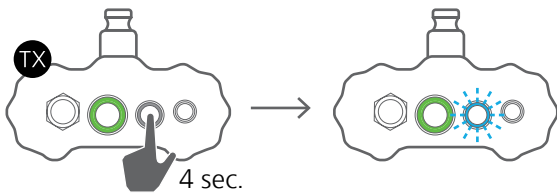

### Activating/deactivating XROC mode

XROC mode can be activated or deactivated either on the TX or via the app.

**i** In XROC mode, only audio channel 1 is being transmitted.

- ▶ Activating XROC mode via the device: Press and hold the Link/XROC button for 4 seconds.
- ✓ The Link/XROC LED slowly flashes blue.
- ▶ Activating XROC mode via the app: On the **Edit** page, tap the XROC ON/OFF button.

**i** Whether XROC mode is active in the transmission path is displayed in the device properties of an RX.

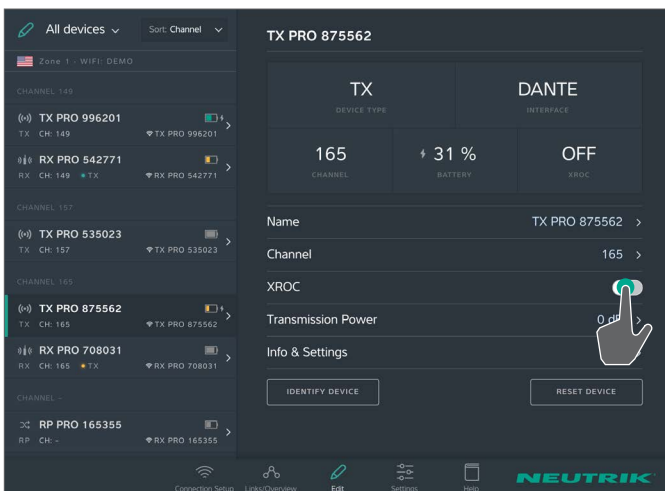



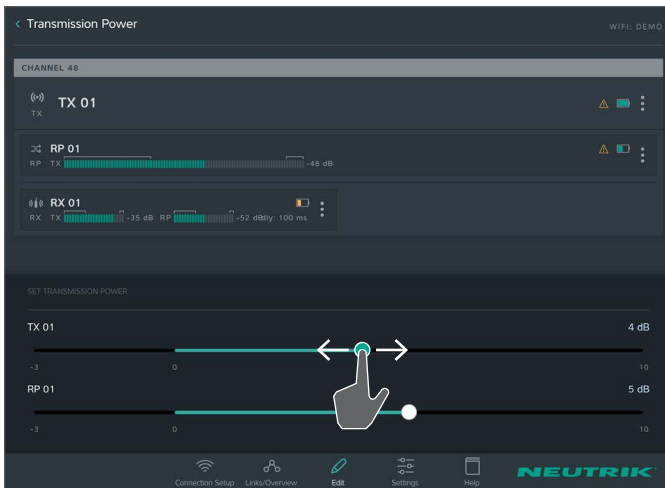

### Setting transmission power

In the default setting, the transmission power is set to 0 dB.

- ▶ If the devices are used indoors or over short distances: Reduce the transmission power.
- ▶ If the devices are used outdoors or over long distances: Increase the transmission power.

**i** If more than 1 TX are used in the network, set the transmission power of all TXs to the same value.

**i** Please consider chapter "4.4.3 Signal quality bar" on page 23 and "4.4.4 Transmission power" on page 24 for a proper setting of transmission power.

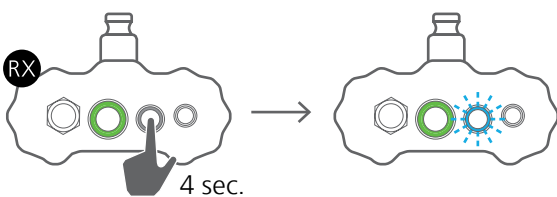

### Activating/deactivating audio delay

- ▶ Activating the audio delay via the device: Press and hold the Link/Delay button for 4 seconds.
- ✓ The Link/Delay LED slowly flashes blue.

- ▶ Activating the audio delay mode via the app: On the **Edit** page, tap the audio delay ON/OFF button.

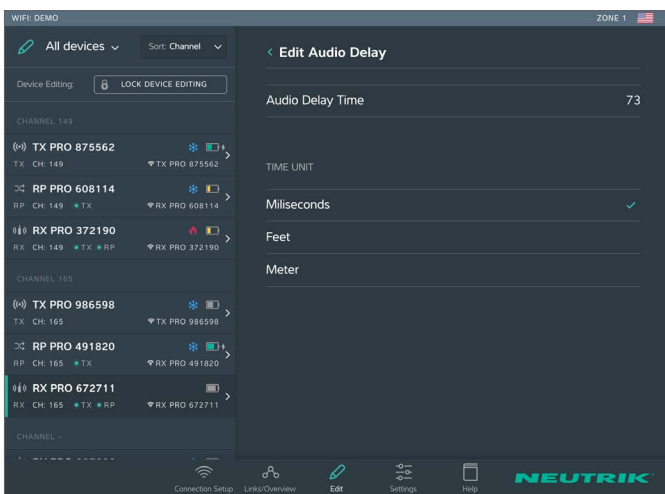
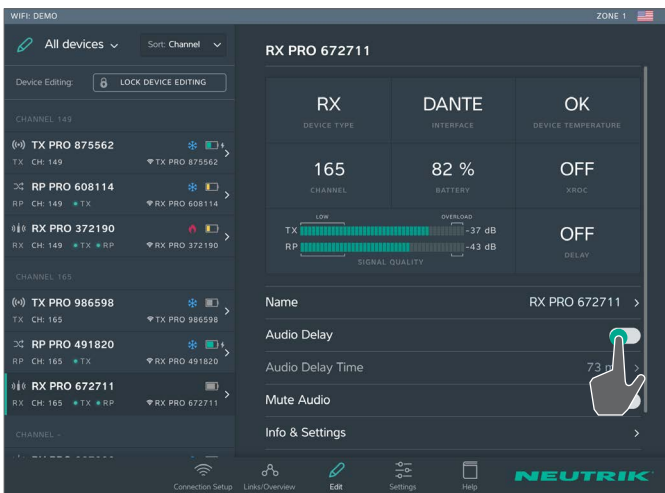

### Changing the audio delay time

- ☑ The audio delay function is active.

- ▶ On the **Edit** page, tap the line **Audio Delay Time**.
- ▶ On the **Edit Audio Delay** page, change the entered delay time.
- ▶ Enter and confirm the new audio delay time.

**i** If the measurement unit is changed, the value is automatically converted to the right unit.

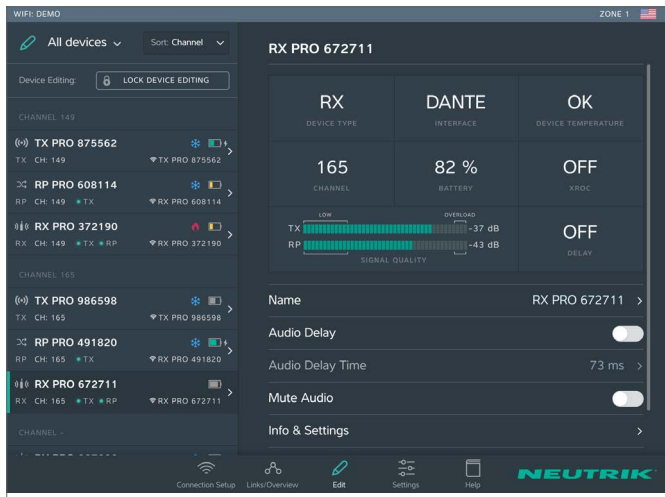

### Mute audio signal

▶ On the **Edit** page, tap the **Mute Audio** button.

**i** A mute icon will be displayed in the Links / Overview window next to the device.

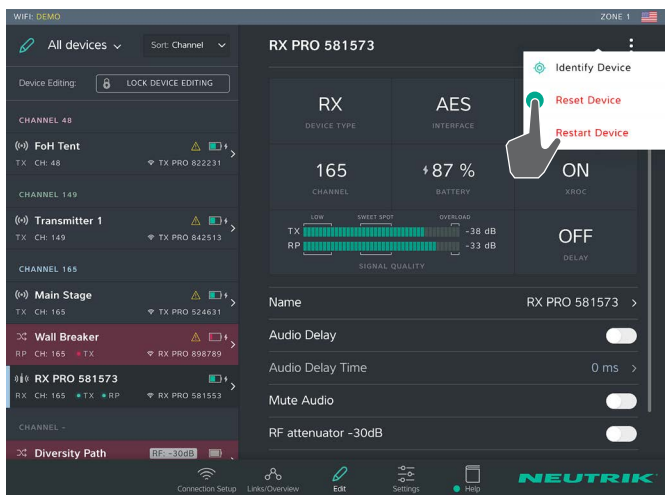

### Resetting the device

Option 1:

- ▶ On the **Edit** page, tap **:** above the monitor section of the selected device.
- ▶ In the options menu, tap **Reset device**.

Option 2:

- ▶ On the **Links/Overview** page, tap **:** at the device.
- ▶ In the options menu, tap **Reset device**.

The following settings are reset with this function:

- Resets the device name to the SSID name.
- Switches off XROC mode (TX).
- Switches off delay (RX).
- Resets the transmission power to the factory setting (0 dB) (TX, RP).
- Makes the SSID public if it was hidden before (TX, RX)
- Turns off the RF attenuator (RX, Advanced Mode)

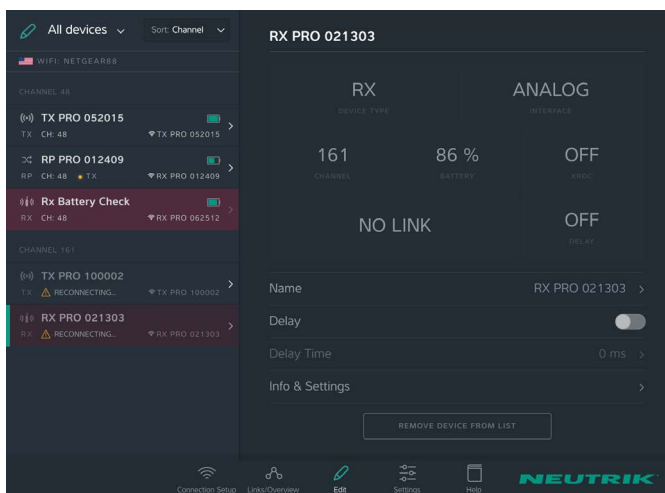

- Turns off the Audio Mute (RX)

### Removing device from app display

If a device is out of the 2,4 GHz range, it can be temporarily removed from the app display.

**i** The **Remove device from list** button is only visible when the device is unavailable to the app.

- ▶ Remove device from display:  
Tap the **Remove device from list** button.
- ▶ Confirm with **OK** in the **Remove device** window.
- ✓ The device is removed from the app display.

**i** As soon as the device is available again, it is displayed in the app.

## 5.7 Editing system settings

### 5.7.1 System Reset

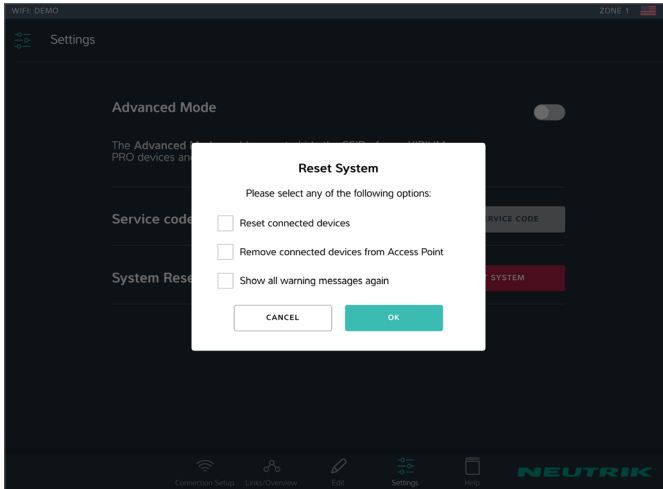

The user can reset various options in the app.

The following options can be selected:

- **Reset connected devices:** All devices are reset to the default setting.
- **Remove connected devices from Access Point:** All devices are removed from the network.
- **Show all warning messages again:** All faded-out warnings and notes are displayed again.

Reset System:

- ▶ On the **Settings** page, tap the **Reset system** button.
- ▶ Activate option:  
Tap the checkbox.
- ▶ Confirm selection with **OK**.
- ✓ The app is reset.

**i** If the XIRIUM PRO devices have been removed from the accesspoint a restart of the devices is necessary!

### 5.7.2 Advanced Mode

The advanced mode is provided for RF specialists. Activating the Advanced mode will allow the user to edit an additional parameter on each RX, called "Auto reboot option". The Advanced mode also allows to hide the SSIDs of the XIRIUM PRO devices.

#### Activating / Deactivating the Advanced mode:

- ▶ On the **Settings** Page, tap the Advanced Mode switch.

**i** An activated autoreboot or a hidden SSID is saved even after a Power Off/On of the device. The app detects whether the autoreboot is turned ON or the SSID is hidden and then automatically turns on the advanced mode.

#### SSID visibility:

In high congested RF environment it is advisable to hide the SSIDs of all devices, in order that no requests will be received by the XIRIUM PRO devices.

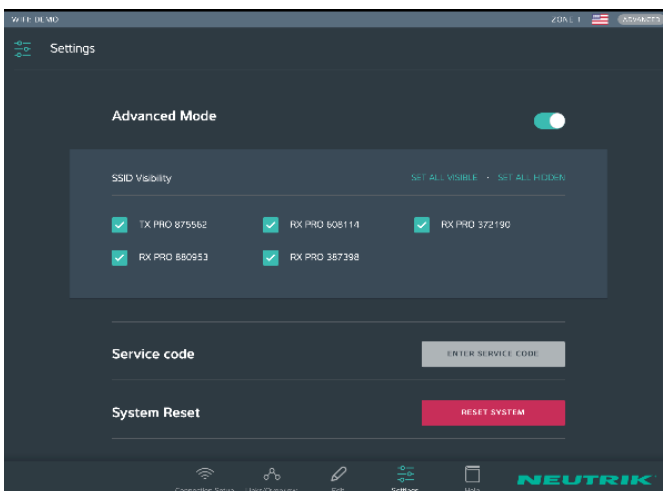

Change SSID visibility:

- ▶ Turn on Advanced Mode to enable the "SSID visibility" parameter in the **Settings** menu.
- ▶ Single devices or all devices at once can be set hidden or visible.
- ▶ A checked box means the SSID is visible.
- ▶ An unchecked box means that this SSID is hidden.

**i** When hiding the SSID in Standalone Mode the app will lose the device for a short time. While an Android tablet will bring the device back in the app automatically, iOS users may have to select the device again in the Wi-Fi settings and then return to the app..

During a change of the SSID visibility in network mode all other options are disabled until the process is finished completely.



**Auto Reboot Option:**

If a single RX has a permanent “No Link” status after another 5 GHz device caused a disturbance within the same channel quite close to the RX, a restart of the device might be necessary. The restart can be set either on the device itself or in the app within the options menu in the EDIT menu or in the Links/Overview menu.

- ▶ Auto reboot brings up the device automatically after a permanent no-link condition lasting 30 seconds.
- ▶ This setting can be turned on individually on each device.

## 5.8 Setting up and mounting the XIRIUM PRO system

### 5.8.1 Positioning the devices

**i** When positioning and setting the devices, observe the information in Section "4.4 Getting started" on page 22.

- ▶ Always keep a minimum distance of 10 feet between the TX and each RX (with mounted 6 dBi antenna and transmission power at -3 dB).

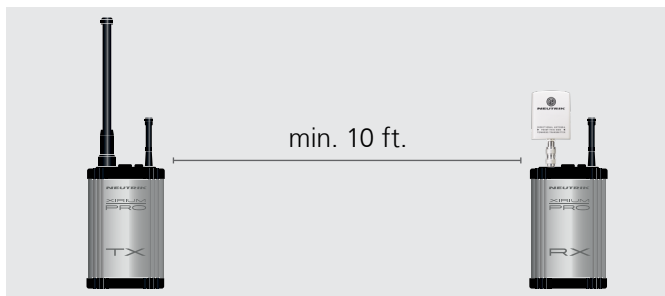

**i** Under the following conditions, select a greater minimum distance between TX and RX:

- XIRIUM PRO devices are operated with the 9 dBi antenna.
- The transmission power is greater than -3 dB.

- ▶ Always mount the devices so the device antennas are at the same height.

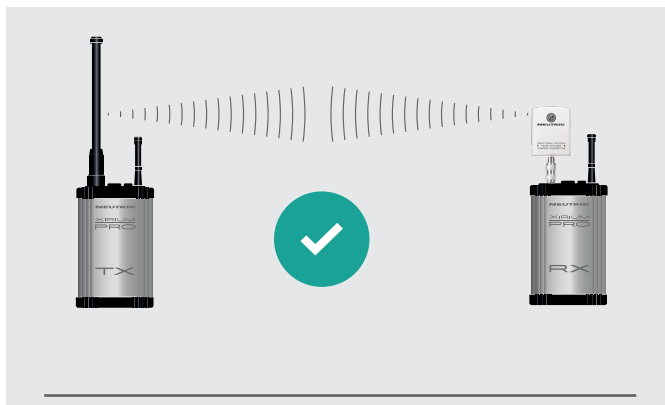

- ▶ If devices are not mounted at the same height: Mount devices so they are parallel with each other.

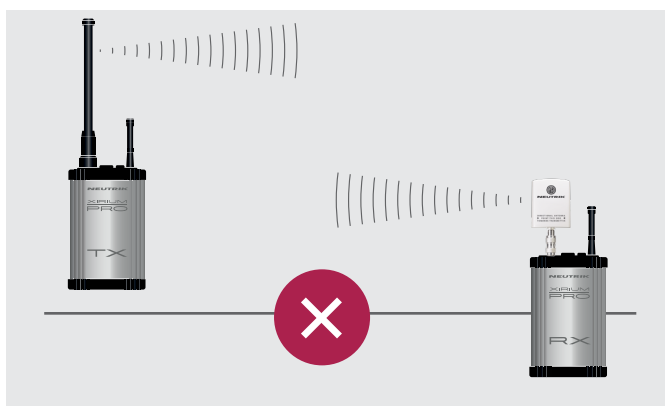

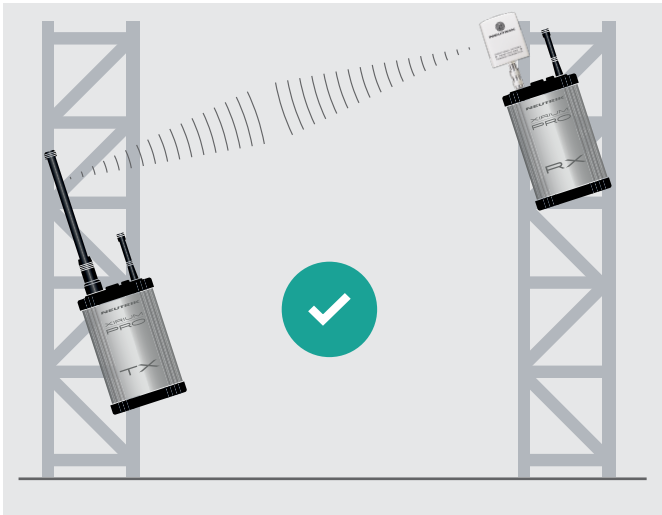

**i** An angled positioning is only allowed if the devices are set to channel 149-165 or used indoors. If the transmission needs to be done in the lower channels (40-48) in an outdoor location a parallel horizontal positioning of the devices with antennas in a vertical position is necessary to comply with FCC regulations.

### 5.8.2 Positioning the repeater

With the repeater, a connection can be stabilized by a redundant signal, obstacles can be overcome, or the

signal can be transmitted over twice the distance.

- ▶ Position repeaters directly in front of obstacles.
- ✓ The signal will be transmitted through the obstacle.

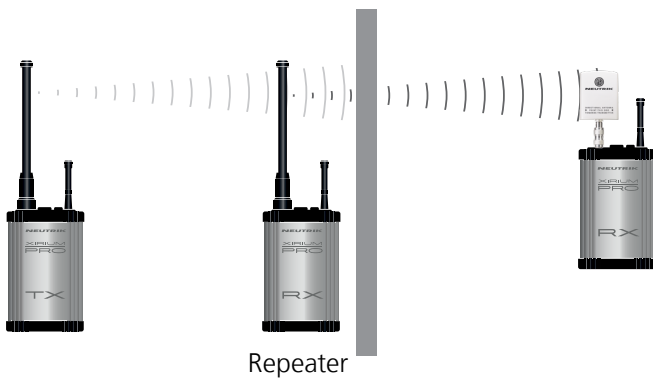

**i** Depending on the signal strength, the repeater can also be positioned directly after the obstacle.

### 5.8.3 Systems with several transmitters

If several transmitters are used in the network, observe the following:

- ▶ Set the transmission power of all TXs to the same value.

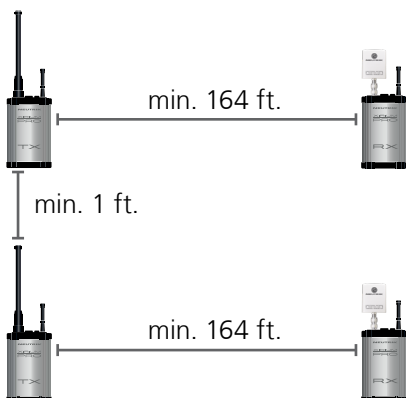

- ▶ Select the transmission channel for the TX in the app so at least one channel is free between each channel used.
- ▶ When positioning the TX, maintain a minimum distance of at least 1 foot between each TX.
- ▶ Increase the recommended minimum distance between TX and RX to 164 feet.
- ▶ The ideal RSSI level is between -60 to -50 dB.

### 5.8.4 Fastening and securing XIRIUM PRO devices

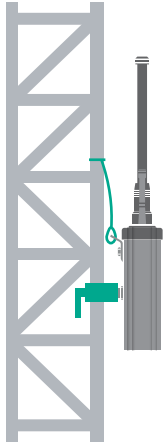
**⚠ WARNING**

**Danger of falling due to incorrectly or incompletely fastened devices!**

- ▶ Always mount and secure the devices according to the instructions.
  
- ▶ Always mount the devices in an upright position.
- ▶ Always mount the devices to the rig with the delivered Manfrotto™ universal mounting clamp.
- ▶ Also secure the devices with the arrestor cable (not included) to the safety lug.

## 5.9 Upgrading firmware

The software "XIRIUM PRO Firmware Upgrade Manager" executes a firmware upgrade on the XIRIUM PRO base stations. The XIRIUM PRO USB data cable (NKXPRO-DATA), supplied with each base station, is used for connection to a computer.

The software can be downloaded at no cost from the NEUTRIK website: [www.neutrik.com](http://www.neutrik.com)

There's an additional driver necessary, which can be downloaded from the Silicon Labs website (<https://www.silabs.com/products/development-tools/software/usb-to-uart-bridge-vcp-drivers>). This driver is required in order to detect the XIRIUM PRO device when connected to a computer.

### 5.9.1 Installing the XIRIUM PRO Firmware Upgrade Manager

#### System requirements

- PC with operating system Microsoft Windows XP, Windows 7, Windows 8, Windows 8.1 or Windows 10.  
PCs with ARM processors (Windows 8 and Windows 10) are not supported.
- Mac with Intel processor and OSX using version 10.8.5 or later.  
Mac computers with PowerPC processors are not supported.

#### Download

- ▶ Download ZIP file with the XIRIUM PRO Firmware Upgrade Manager Setup from the NEUTRIK website and save it.

#### Installing the software

- ▶ Double-click on the [XIRIUM PRO Firmware Upgrade Manager](#) application.
- ✓ The main window appears:
- ▶ Select a location to install the software

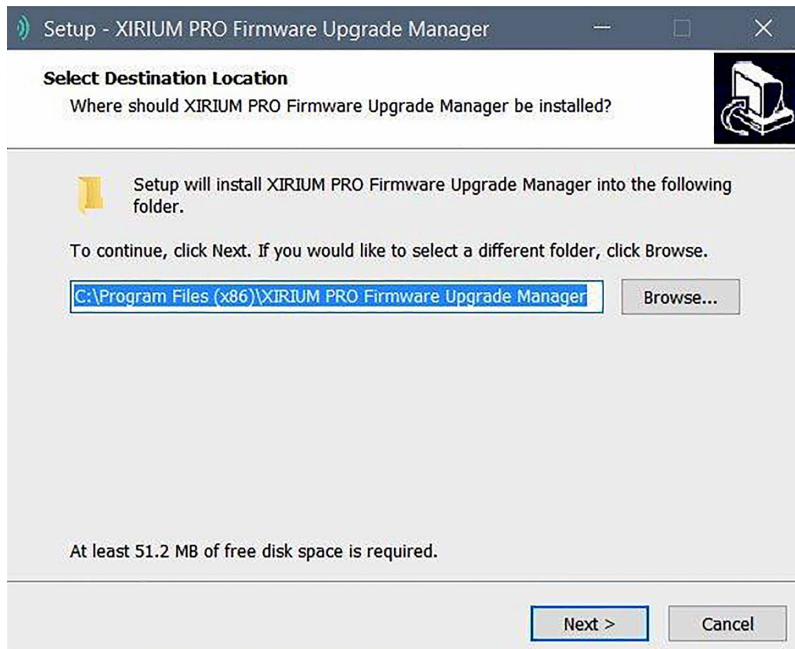

- ▶ Click the [Next](#) button.

- ▶ Follow the subsequent installation steps.



### 5.9.2 Executing a firmware upgrade

- ▶ Download the ZIP file with the current firmware from the NEUTRIK website and save it.
- ▶ Start the software:
  - Double-click the program icon on the Desktop.
- ✓ The program window appears:

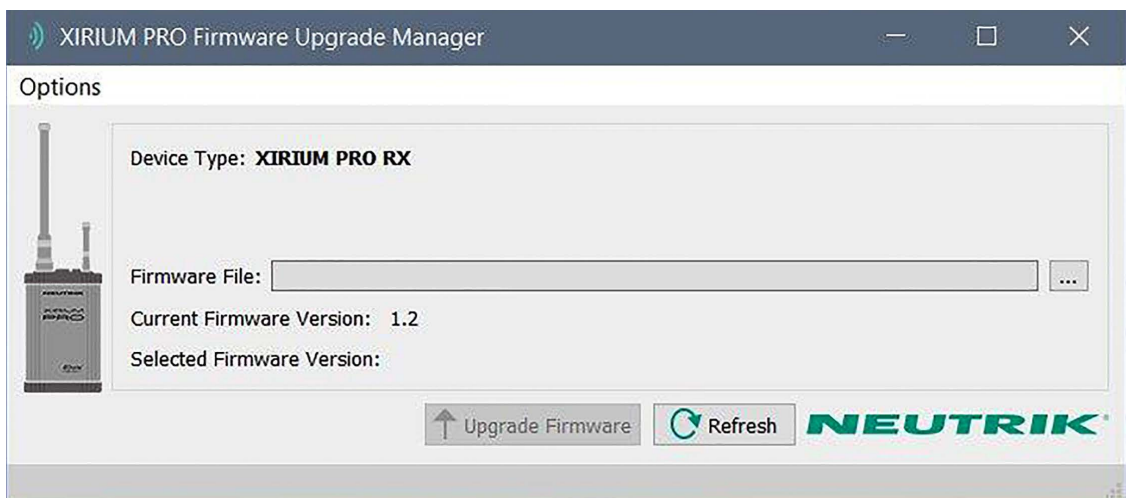
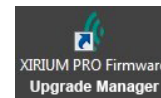



- ▶ Connect the XIRIUM PRO base station to the computer.
- ▶ Click the **Refresh** button to update all the displays.

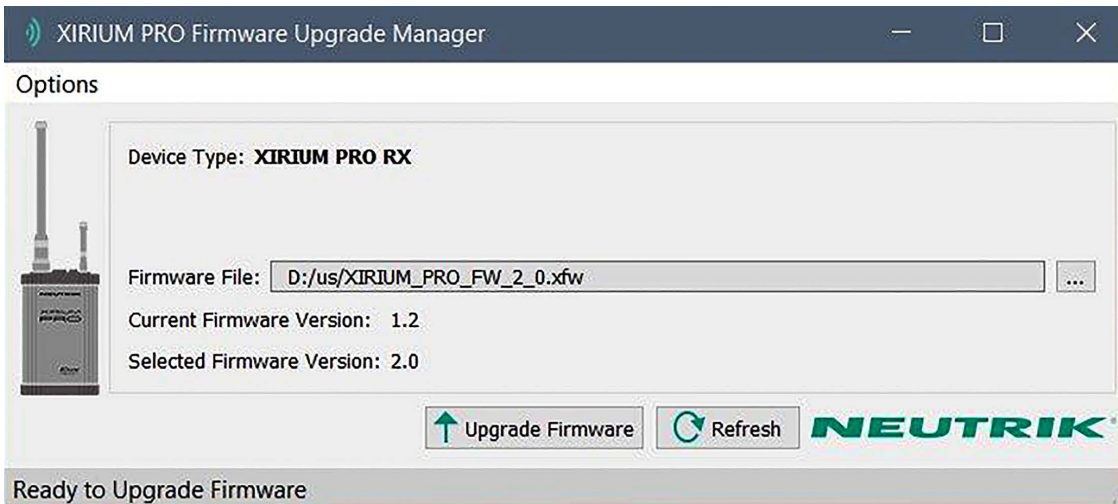

- ▶ Select the firmware file from the file selection field **Firmware File**.
- ✓ The version number of the new firmware is displayed in **Selected Firmware Version**.
- ✓ Execute the upgrade:
  - Click the **Upgrade Firmware** button.
- ✓ The software automatically executes the upgrade.

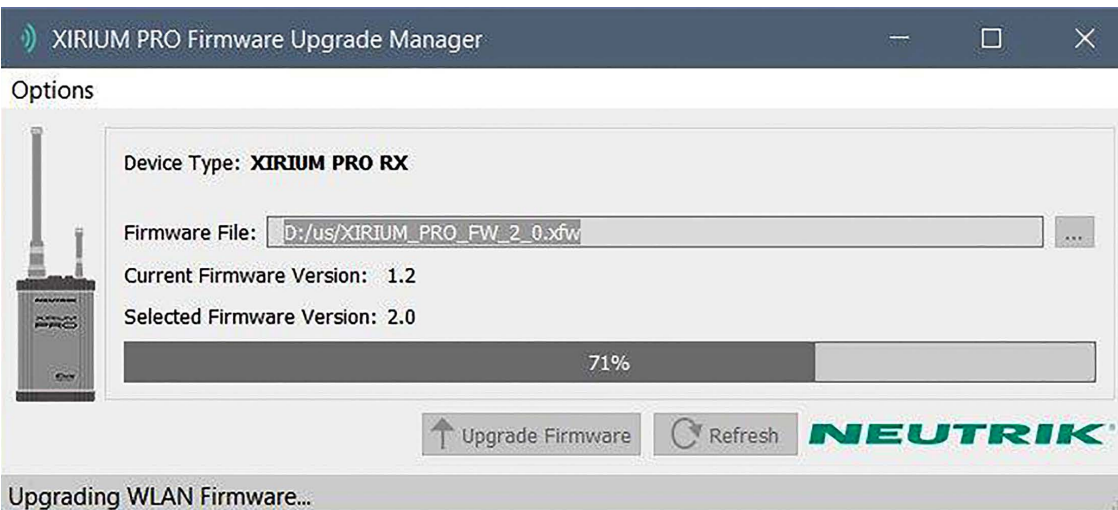

- ✓ As soon as the upgrade has completed, the software displays a message window.



- ▶ Disconnect the XIRIUM PRO base station from the computer.

### 5.9.3 Uninstalling the XIRIUM PRO Firmware Upgrade Manager

- ▶ Uninstall the software through the add/remove function of the operating system.

## 6 Troubleshooting

Message	Fault	Cause	Solution
Reconnecting...	WLAN connection to device not available.	Battery empty	▶ Connect device to power supply.
		Device out of 2.4 GHz network range.	▶ Avoid obstacles influencing reception. ▶ Position device or access point at a different location.
No Link!	RX does not receive a signal from TX.	TX battery empty	▶ Connect device to power supply.
		Device out of 5 GHz network range.	▶ Avoid obstacles influencing reception. ▶ Position TX at a different location. ▶ Add repeater to transmission path.
RSSI level "low" area	RX repeater receives a weak signal.	Distance between TX and RX / repeater too high.	▶ Increase transmission power on TX/repeater. ▶ Decrease distance between TX and RX/repeater by a few meters. ▶ If no repeater in application: Add repeater to transmission path.
RSSI level "overload" area	RX repeater receives a signal that is too strong	Distance between TX and RX/repeater too low.	▶ Decrease transmission power on TX/repeater. ▶ Increase distance between TX and RX/repeater by a few meters.
Signal quality bar is orange Signal quality bar is red	Packet loss is critical Packet loss is too high	Some reflections cause a critical or high packet loss at this position.	▶ Position devices at a slightly different location.
Access Point lost	Connection between tablet and access point used is broken.	Tablet out of range of access point.	▶ Position device or access point at a different location.
		Flight mode active on tablet.	▶ Deactivate flight mode on tablet.
Access point changed	Tablet connected with a different access point.	Tablet out of range of access point.	▶ Position device or access point at a different location.

## 7 After operation

### 7.1 Dismounting devices

- ▶ Disconnect devices from audio sources/sinks.
- ▶ Disconnect devices from power supply and pull mains plug.
- ▶ Dismount antennas.
- ▶ Remove modules from device.

### 7.2 Transporting

- ▶ Always transport devices and accessories in the original packaging.

### 7.3 Storage

- ▶ If devices are not used for a longer period:  
Disconnect devices from power supply and pull mains plug.
- ▶ Always store devices and accessories in the original packaging.
- ▶ Always store devices in a clean, dry location.
- ▶ Always protect devices from dirt, dust, heat, humidity and moisture.

### 7.4 Cleaning and care

#### **⚠ DANGER**

#### **Danger of electric shock and property damage due to improper cleaning!**

- ▶ Disconnect device from power supply before cleaning.
  - ▶ Never immerse device or accessory in water under any circumstances.
  - ▶ Never spray device or accessory with liquids under any circumstances.
- 
- ▶ Wipe the surfaces of the device and accessory with a soft cloth slightly moistened with a mild soap solution.
  - ▶ Never use aggressive, solvent-based or abrasive cleaning agents under any circumstances.
  - ▶ Never use rough materials (e.g., cleaning cloths or sponges with a rough coating).

### 7.5 Maintenance and repair

The XIRIUM PRO devices do not contain any parts which can be maintained or repaired by the user.

- ▶ These devices may only be repaired by a authorized XIRIUM PRO repair center.
- ▶ Check devices regularly for visible damage to the housings, operation elements, connections, cables and plugs.
- ▶ If damage is detected, do not use devices under any circumstances
- ▶ Immediately disconnect devices from power supply.
- ▶ Replace defective cables or accessories immediately.

## 7.6 Disposal



- ▶ Dispose of XIRIUM PRO devices and accessories in accordance with the applicable local regulations.
- ▶ Never dispose of electrical devices or electrical accessories such as cables, plug, batteries or components with household wastes under any circumstances.

- ▶ Dispose of packaging and packaging elements in accordance with the applicable local regulations.
- ▶ Take device components made of plastic, metal or other recyclables for reclamation in accordance with the applicable local regulations.

## 8 Appendix

### 8.1 Integrating DANTE®

#### 8.1.1 Introduction to DANTE®

DANTE® stands for **D**igital **A**udio **N**etwork **T**hrough **E**thernet and is an audio network protocol developed by the Australian company Audinate. DANTE® delivers uncompressed, multichannel, low-latency digital audio over a standard Ethernet network using Layer 3 IP packets. A TX DANTE® module is able to transmit up to two channels of digital audio, while the RX DANTE module can receive two signals of a DANTE® network.

**i** When XROC mode is enabled, only one channel is transmitted and received in a transmission path, because the data rate is then lowered.

All products on which DANTE® is enabled work together to deliver perfectly synchronized audio. This is managed through a single software application called “Dante Controller”.

Dante Controller is a free software application that enables routing audio and configuring devices in a Dante network. Setting up a DANTE® network is very easy. Dante Controller offers automatic device detection, one-click signal routing and user-editable device and channel labels.

A XIRIUM PRO device with an integrated DANTE® module can be connected to the DANTE® network using common CAT5e or CAT6 cables. If a network switch is included in the system, it should be at least a 1 Gbit network switch.

#### 8.1.2 Enabling a DANTE® link

- Connect the computer to the DANTE® network with a standard CAT5e or CAT6 cable
- The DANTE Controller software is installed (<https://www.audinate.com>).

- ▶ Run the Dante Controller software.
- ▶ In the routing menu, click on the + symbols of the devices.

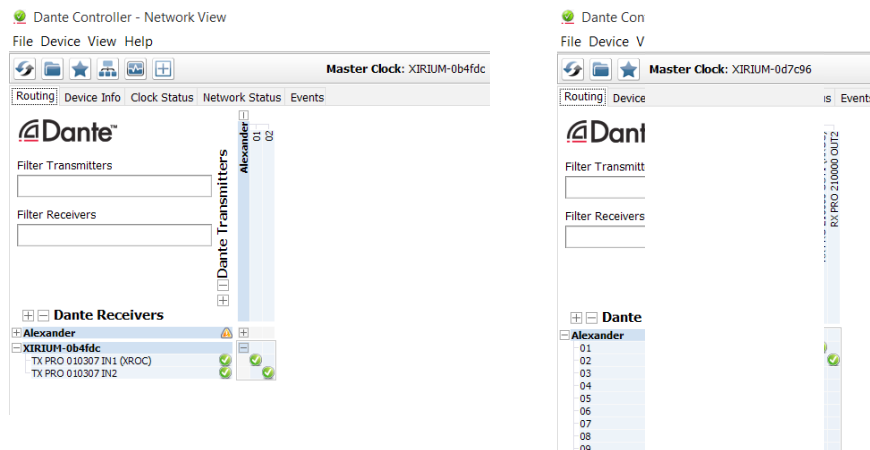

- ▶ Establish the desired link.

**i** The XIRIUM PRO TX devices appear as DANTE® receivers, and vice versa!

## 8.2 Access point settings

Using an access point makes it possible to operate the app in network mode. This way, the entire XIRIUM PRO system can be configured and monitored via the app.

### 8.2.1 Recommended settings

Any conventional access point can be used to set up a XIRIUM PRO network. Neutrik recommends the following settings for the access point:

- For the strongest security option, use WPA2-AES as security protocol for authentication.
- If the access point has a dual-band radio, deactivate the 5 GHz band and only leave the 2.4 GHz band activated.
- Make sure the http and https protocols are not blocked.



Please double check with local channel management which channel can be used in order to avoid uncoordinated usage.



It is not recommended to change the 2.4 GHz channel during a show. A single client device may not receive the channel change information due to increased RF traffic and hence wouldn't be accessible anymore via the access point on the app.



In a congested RF environment some devices might not be displayed in the app immediately. It can take a few minutes until all devices are displayed.

## 8.3 Technical specifications

### General specifications

Radio frequency carrier range	IEEE 802.11a, UNII-1 band from 5200 MHz to 5250 MHz (channels 40 – 48) and UNII-3 band from 5725 MHz to 5825 MHz (channels 149 – 165), license-free
Data protocol	Proprietary (DiWA technology)
Transmit power	Conducted 26 dBm / 32 dBm EIRP (with 6 dBi antenna) / 35 dBm EIRP (with 9 dBi antenna), FCC compliant
Range	Up to 1000 m point to point (LOS), longer range depending on obstacles, reflexions, interferences, XROC mode
Monitor & Control	2.4 GHz band, app available for iOS and Android tablets
Requirement for Android tablets	> 7 inch + min. 525 dp (device independent pixels)

### Audio performance (analog to analog per wireless link)

THD + Noise (TX Gain = min.)	< 0.01 % @ 20 Hz – 10 kHz, 4 dBu
Frequency response	± 0.3 dB @ 20 Hz – 20 kHz ref. 1 kHz
Dynamic range	> 105 dB @ 1 kHz, A-weighted
> 105 dB @ 1 kHz, A-weighted	< -80 dB @ 20 kHz
Number of audio channels @ 24 Mbps	2
Number of audio channels @ 6 Mbps	1 (XROC mode)
Number of receivers (RX only)	Unlimited number of RX clients
Converter resolution (ADC & DAC)	24 bit
Sampling rate	48 kHz
Latency (Delay)	3.6 ms (analog to analog)
Transmission method	Compression-free, no reduction of converted data
Operating temperature	32 °F to +122 °F / 0 °C to +50 °C
Storage temperature	-4 °F to +176 °F / -20 °C to +80 °C

### Additional digital audio interfaces

AES/EBU	24 bit / 48 kHz according to AES3-2003
Dante AoE (Audio over Ethernet)	Proprietary protocol by Audinate®



**TX SPECIFIC CHARACTERISTICS**

Antenna 5-6 GHz – Audio transmission	Omni-directional, 6 dBi, 25° Elevation and 360° Azimuth, N-connector male (direct mount)
Antenna 2.4 GHz – Control data transmission	1/2 wave dipole with SMA female connectors
Number of audio channels @ 24 Mbps	2
Number of audio channels @ 6 Mbps	1 (XROC mode)

**Analog input specs**

Input mode	Input level			
	Input Imp. kOhm	Rated Source Imp. Ohm	max.* dBu	Connector type
Line (balanced)	10	1000	22	XLR
Indicators	LEDs: Power ON / Start up / Low battery status / XROC mode / Linking process / Audio transmission			
Controls	Power ON / Linking process / XROC mode			
Power supply	Mains input over powerCON TRUE1 (100-240 VAC 50/60 Hz) or internal battery **			
Dimensions (w x h x d)	5.6 x 2.5 x 9.7 in / 142 x 64 x 247 mm (without antennas)			
Weight	1.59 lbs / 0.72 kg			
Optional accessories	Module interfaces (Analog, Digital, Dante), mounting clamp			

\* maximum input level before signal overflow, 0 dBu = 0.775 V rms

\*\* typical battery runtime 10 hours, depending on type of module, transmission power settings, XROC mode, number of charging cycles and operating temperature

## RX SPECIFIC CHARACTERISTICS

Antenna 5-6 GHz – Audio transmission	Omni-directional, 6 dBi, 25° Elevation and 360° Azimuth, N-connector male (direct mount)
Antenna 2.4 GHz – Control data transmission	1/2 wave dipole with SMA female connectors
Number of audio channels	2

## Analog output specs

Output type	Output level				
	Output Imp. Ohm	Rated Load Imp. kOhm	Nominal* dBu	Max. Level dBu	Connector type
Line (balanced)	< 800	10	0	22	XLR
Indicators	LEDs: Power ON / Start up / Low battery status / Audio delay / Linking process / Audio reception				
Controls	Power ON / Linking process / Audio delay				
Power supply	Mains input over powerCON TRUE1 (100-240 VAC 50/60 Hz) or internal battery **				
Dimensions (w x h x d)	5.6 x 2.5 x 9.7 in / 142 x 64 x 247 mm (without antennas)				
Weight	1.59 lbs / 0.72 kg				
Optional accessories	Module interfaces (Analog, Digital, Dante, Repeater), mounting clamp				

\* if TX source = 0dBu

\*\* typical battery runtime 10 hours, depending on type of module, transmission power settings, XROC mode, number of charging cycles and operating temperature

## Antennas – Omni-directional antenna / Frequency band: 5.150 GHz - 5.875 GHz

Type	NXPA-6-360-25	NXPA-9-360-12.5
Gain	6 dBi	9 dBi
Beam width horizontal	360°	360°
Beam width vertical	25°	12.5°
Connector	N-connector male	N-connector male
Dimensions	10.63 in / 270 mm	14.57 in / 370 mm
Weight	0.75 lbs / 0.34 kg	0.75 lbs / 0.34 kg
Operating temperature	32 °F to +122 °F / 0 °C to +50 °C	32 °F to +122 °F / 0 °C to +50 °C



#### Liechtenstein (Headquarters)

Neutrik AG, Im alten Riet 143, 9494 Schaan  
T +423 237 24 24, F +423 232 53 93, neutrik@neutrik.com

#### Germany / Netherlands / Denmark / Austria

Neutrik Vertriebs GmbH, Felix-Wankel-Straße 1, 85221 Dachau, Germany  
T +49 8131 28 08 90, neutrik@neutrik.de

#### Great Britain

Neutrik (UK) Ltd., Westridge Business Park, Cothey Way  
Ryde, Isle of Wight PO33 1 QT  
T +44 1983 811 441, sales@neutrik.co.uk

#### France

Neutrik France SARL, 52 rue d'aguesseau, 1er etage, 92100 Boulogne-Billancourt  
T +33 1 41 31 67 50, info@neutrik.fr

#### USA

Neutrik USA Inc., 4115 Taggart Creek Road, Charlotte, North Carolina, 28208  
T +1 704 972 3050, info@neutrikusa.com

#### Japan

Neutrik Limited, Yusen-Higashinohonbashi-Ekimae Bldg., 3-7-19  
Higashinohonbashi, Chuo-ku, Tokyo 103  
T +81 3 3663 47 33, mail@neutrik.co.jp

#### Hong Kong

Neutrik Hong Kong LTD., Suite 18, 7th Floor Shatin Galleria  
Fotan, Shatin  
T +852 2687 6055, sales@neutrik.com.hk

#### China

Ningbo Neutrik Trading Co., Ltd., Shiqi Street, Yinxian Road West  
Fengjia Villiage, Hai Shu District, Ningbo, Zhejiang, 315153  
T +86 574 88250833, sales@neutrik.com.cn

#### India

Neutrik India Pvt. Ltd., Level 3, Neo Vikram, New Link Road,  
Above Audi Show Room, Andheri West, Mumbai, 400053  
T +91 982 05 43 424, anklesaria@neutrik.com

#### Associated companies

##### Contrik AG

Steinackerstrasse 35, 8902 Urdorf, Switzerland  
T +41 44 736 50 10, contrik@contrik.ch

##### H. Adam GmbH

Felix-Wankel-Straße 1, 85221 Dachau, Germany  
T +49 08131 28 08-0, anfrage@adam-gmbh.de

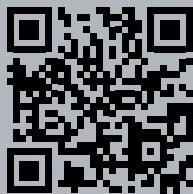

[www.neutrik.com](http://www.neutrik.com) / [www.xirium.net](http://www.xirium.net)